



Glass & Glazing Federation

CI/SfB

Ro

Summer 2011

Issue 3



The Good Practice Guide for the Installation of Replacement Windows and Doors

Contents

Introduction and Scope	5
Section 1 – Principles	6
General Requirements	6
Strength and Performance	6
Security Considerations	8
Safety Considerations	9
Planning Considerations	10
Section 2 - Surveying	11
General	11
Building Regulations	11
Suitability of Aperture	11
Services in the Aperture	12
Design for Weather Performance	12
Lintels	12
Brickwork Removal	12
Bow, Oriel and Dormer Windows	13
Bay Windows	13
Roof Windows	13
Coupled/Combined Frames	14
Opening Type and Direction	14
Doorsets	14
Frame Drainage	15
Decorative Glazing	15
Measurement	15
In-check Reveal	16
Manufacturing Sizes	16
Asbestos	17
Surveyor's Check List	18

Contents

Section 3 - Installation	19
General	19
Window Removal Techniques	19
• Timber Framed Windows and Doors	20
• Box Sash Windows	20
• Metal Framed Windows	20
• PVC-U Framed Windows and Doors	21
• Sub-Sills	21
Window and Door Fixing	21
• Fixings	22
• Fixing Distances	23
• PVC-U Windows and Doors	23
• Timber Windows and Doors	24
• Aluminium Windows and Doors	25
• Steel Windows	25
Roof Windows	25
Bay Poles	26
Installation Packers	27
Finishings	27
Frame Position	27
Open Cavities	27
Box Sash Windows	28
Glazing	28
Scratched Glass	29
Finishing Off and Making Good	29
Sealing	29
Final Inspection	30
Final Inspection Check List	31

Contents

Section 4 - Maintenance	32
Glass	32
PVC-U Frames	32
Aluminium Frames	32
Timber Frames	32
Steel Frames	33
Roof windows	33
Sealants	33
Gaskets and Seals	33
Hardware and Fittings	33
Annex A	35
Section 5 - Building Regulations	37
AD A - Structure	38
AD B - Fire Safety	41
AD C - Resistance to Contaminants and Moisture	46
AD F - Ventilation	49
AD J - Combustion Appliances and Fuel Storage Systems	52
AD K - Protection from Falling, Collision and Impact	55
AD L - Conservation of Fuel and Power	58
AD M - Access To and Use of Buildings	60
AD N - Safety Against Impact	62
Section 6 – Bibliography and Descriptions	65

Introduction / Scope

This good practice guide has been developed by the GGF Window and Door Group - Technical Committee. It is intended that this guide will assist those involved with the **Survey, Installation and Use of Replacement Windows and Doors for Dwellings within England and Wales**. This guide will also be of benefit to those responsible for ensuring that the fenestration complies with the Building Regulations.

This updated edition includes guidance on the safe removal of asbestos products, the removal and replacement of bay windows and considerations of sealants.

Section 1: Principles

General Requirements

The following matters need to be considered;

- The need to provide a weather proof solution
- The need to provide natural light and ventilation;
- Design for safety in use;
- Means of escape in case of fire;
- Security against unauthorised entry;
- Design for safety when cleaning;
- Maintenance;

Note: The type of occupancy, and the age range of both occupants and visitors to the building should also be considered. BS 8213-1:2004 advises that a risk assessment be conducted by the designer (in the case of domestic replacement windows this is the person or organisation taking the order from the client), taking account of the relative priority needs established in each situation. If a significant change of use of the building occurs, the risks should be reassessed.

Strength and Performance

The performance characteristics of external windows and doors are covered by European Standard EN 14351. The Standard identifies performance characteristics that are applicable to windows and doors and it identifies the test methods that should be used to establish these characteristics. However, it does not actually specify the level of performance that is required for the characteristics, because this varies according to the climate or local building regulations.

This has been adopted as a British Standard, BS EN 14351. This standard will be covered by the Construction Products Regulation regarding CE marking of products.

Section 1: Principles

BS 6375 Part 1

Explains how to calculate the appropriate design wind load for a particular location and then how to use that wind load to specify the appropriate weather resistance class for the proposed windows or doors. It specifies the exposure categories and classifications that can be achieved and the test methods that should be used to determine these results. Aspects covered include air permeability, watertightness and wind resistance, including safety of the product under extreme loading conditions.

The Standard gives an abbreviated method for calculating wind loads for low rise applications within the British Isles. This is a conservative way of assessing wind loads. If a more accurate calculation of wind load is required, or if the product use falls outside the scope of this document, then reference should be made to the building designer or to BS EN 1991 A structural engineer or other competent person should always complete calculations.

BS 6375 Part 2

Specifies the performance requirements for the operation and strength of windows and doors. Test procedures and recommended performance levels are listed for the maximum forces that can be allowed to operate hinges and handles to open sashes, and for resistance to vertical loads, resistance to static torsion, racking, load bearing capacity of safety devices, resistance to soft and heavy body impact, resistance to hard body impact and resistance to repeated opening and closing.

BS 6375 Part 3

Covers the performance requirements for all the other characteristics identified in BS EN 14351 which are not dealt with in BS 6375 Parts 1 or 2. It covers items such as reaction to fire, acoustic performance, bullet resistance, explosion resistance and burglar resistance. For each of the characteristics, comment is made on an appropriate level of performance and the test methods to be used are specified. However, it should be noted that it is not necessary for windows and doors to always comply with all of the characteristics, but if a certain characteristic needs to be specified then it should be in accordance with BS 6375 Part 3.

Note: It is recommended that all specifiers and manufacturers be familiar with all parts of BS 6375.

Section 1: Principles

Regulations

There is currently no requirement within the England and Wales Building Regulations regarding the level of security provided by windows and doors. However, there may be a local requirement for enhanced security windows through imposed planning conditions, 'Code for Sustainable Homes' etc. If enhanced security windows and doors are required, the performance of those products is based on BS EN 1627 – 1630. There may also be additional prescriptive requirements based on the Secured by Design specification of the Association of Chief Police Officers (ACPO) Crime Prevention Initiatives.

The issue of security is currently being reviewed by the Home Office (HO) and Department of Communities and Local Government (DCLG) so there may be changes to the statutory requirements in the future.

Before the introduction of the European security standards contained in EN 1627 -1630 and the publication of the UK versions, BS EN 1627 - 1630, the UK's enhanced security standards were BS 7950 for windows and PAS 24 for doors . The new European Standards do not address some of the Modus Operandi (MO) sometimes used by the opportunist burglar within the UK and as a result a national foreword has been included within BS EN 1627 – 30. Additional requirements for enhanced security windows and doors fitted in the UK have also been added. Third party certification using either EN1627 – 1630 plus the additional requirements above or PAS 24:2012 is recommended by the GGF as a means of demonstrating compliance.

The existing standard for windows, BS 7950 is due to be withdrawn in January 2012 and window security requirements will be incorporated into PAS 24:2012. This revised standard will contain the requirements for Doors (Annex B) and Windows (Annex C) and the cylinder specific requirements for compliance through the EN 1627 – 1630 route (Annex A).

Best Practice Note:

The GGF recommends that vulnerable windows and doors should be manufactured to enhanced security standards that meet the requirements of BS EN 1627 – 30 or PAS 24:2012. The vulnerability of windows and doors should be determined by a site risk assessment carried out by a competent person. Generally, windows and doors at ground floor or basement level and those on first floor that are easily accessible (via flat roofs, balconies etc.) are considered to be vulnerable.

Section 1: Principles

Safety Considerations

There are two main aspects concerning safety of replacement windows. These are:

1. The appropriate use of safety glazing in critical locations

Safety glazing should be installed in critical locations. Reference should be made to Approved Document N1 of the Building Regulations for guidance and indications of critical locations.

Note: Further details concerning the Building Regulation requirements can be found in Section 5 of this guide.

2. Safety in use and during cleaning

Advice on safety in use and during cleaning is given in BS 8213 Part 1. This standard recommends a risk assessment approach to window design. It states that windows should be easy to operate, open safely without being a hazard to passers by, and minimise the risk of falling through. It explains that safe use depends on window location, window type, safety fittings, guarding, and window construction and installation. Risks in use and during cleaning are given for all types of window.

BS 8213 also gives advice on the requirement for, and use of restrictors. It states that safety restrictors should be fitted to accessible opening lights where children or adults are at risk of falling out. An accessible opening light is defined as an opening light, any part of which is 1500mm or less above floor level.

Any safety restrictor should limit the initial movement so that a clear opening of no more than 100mm is achieved and that release is only achievable by manipulation not normally possible by a child under 5 years old.

Restrictors should meet the requirements of BS 6375-2. EN 14351-1 clause 4.8 "load bearing capacity of safety devices" specifies testing in accordance with EN 14609 or EN 948 at a load of 350 N.

If it is deemed necessary to fit safety restrictors to fire escape windows, then the positioning of the device should be such that while achieving the above requirements, the occupant does not have to spend time searching for the release mechanism in the case of a fire and that the release can be achieved without prior instruction and cannot be confused with other operations.

Section 1: Principles

Planning Considerations

Before replacing windows consideration should be given to any possible planning issues that may arise. The flow chart below outlines the thought process, however if doubts remain, advice from local building control should always be sought

Note: Any alterations from a flat window to a bay or bow window, may require planning approval and should be referred to the Local planning office.

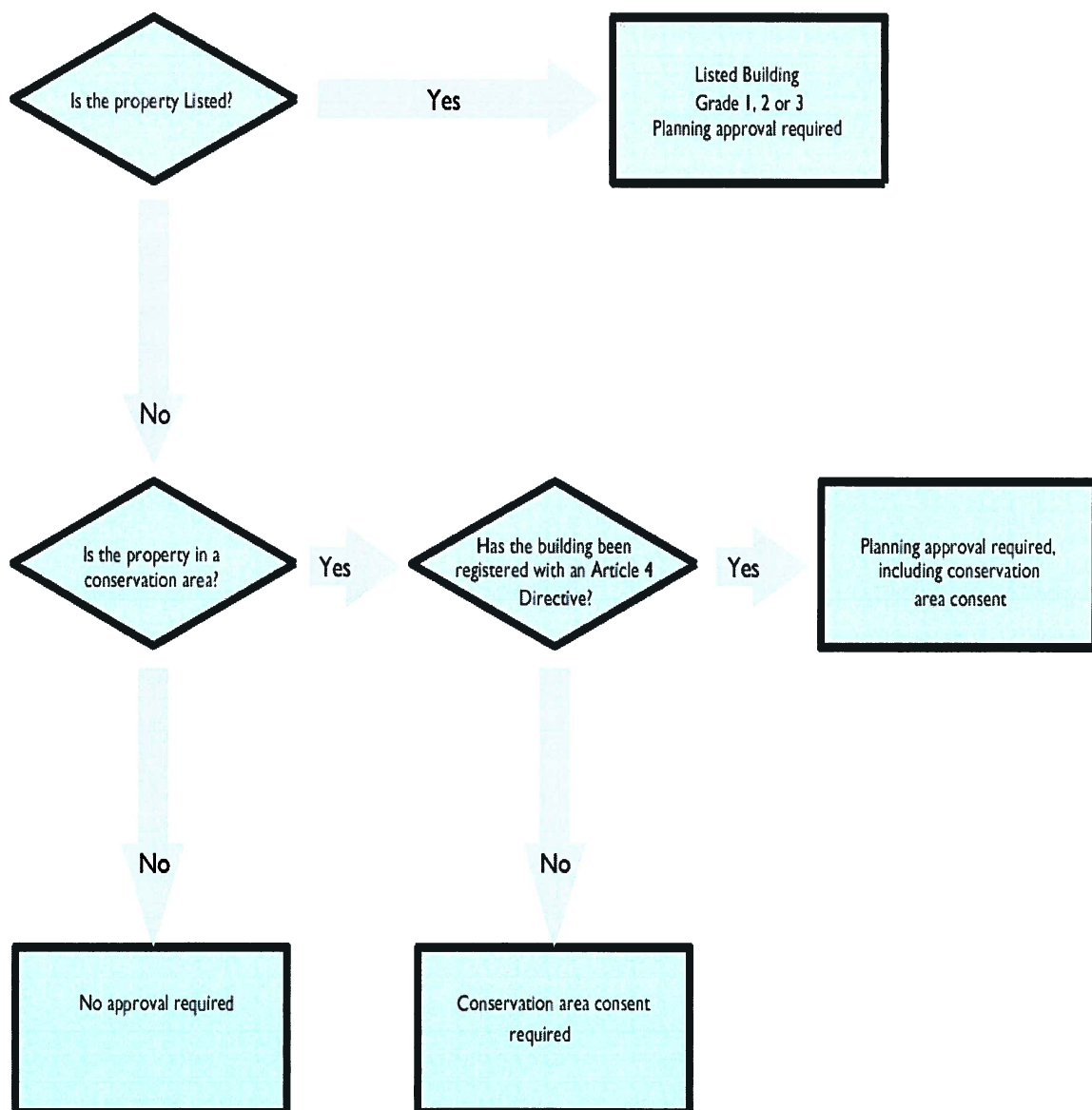

Section 2: Surveying

General

Good surveying is the basis of ensuring a quality installation. Surveyors should be fully trained in window and doorset installation techniques, and in the requirements of surveying for the particular window system being used. For future reference with respect to Building Regulation compliance, it is advisable to record (ideally with the aid of a photograph) the style of the window or door being replaced along with the size of any opening lights and the position of any mullions and transoms. Ideally, this would be witnessed by the householder and countersigned.

The surveyor or other competent person should carry out a risk assessment for both the installation process and the suitability of the window design. Information on the safety of windows in use and during cleaning is given in BS 8213-1. The requirements of Health and Safety regulations should also be considered. When sub-contracting, the surveyor, as part of the installation risk assessment, should ensure that the main contractor will provide a safe working environment including safe access. When a load-bearing situation is suspected or confirmed then reference should be made to the manufacturer's instructions and guidance provided within Approved Document A: Structure.

Building Regulations

The Building Regulations exist to ensure the health and safety of people in and around all types of buildings. They also provide for energy conservation, access to and use of buildings.

Where windows and doorsets are to be replaced (but not where they are to be repaired only, as repair work does not fall within the definition of building work) the replacement work should comply with the requirements of Parts L and N of Schedule 1. In addition, after the work has been completed, the building should not have a lesser level of compliance with the other applicable parts of Schedule 1.

For detailed Building Regulation information see Section 5 of this guide.

Suitability of Aperture

The surveyor should check for any apparent defects and deficiencies around the structural opening. If any defects are found, then the customer should be notified, and agreement reached as to who is responsible for rectifying these defects prior to the new windows or doorsets being installed.

Note: For large replacement contracts, it may be advisable to remove one window to check the condition of the reveals and existing DPC, in so far as this is possible.

Section 2: Surveying

Services in the aperture

The presence of any electrical or specialist items such as television aerials and telephone wires in the aperture should be noted. Wherever possible such services should be routed around, and not through, the outer frame of the window or door. When this is not possible, a solution should be agreed with the customer, which does not compromise the performance of the product. The presence of any curtain tracks in the aperture should be noted. This is particularly important for inward opening windows and net curtains. These could cause problems either during installation, or interfere with the function of the window and doorset after the installation. Action to prevent any problems should be agreed with the customer prior to the installation.

Design for weather performance

The surveyor should determine the design wind load for the application, and then specify windows and doors that are suitable for that exposure. BS 6375-1 gives guidance on the selection and specification of windows and doors for weather performance.

Note: Reference to the manufacturer should be made in case of doubt.

Lintels

It is essential to maintain the integrity of the building.

If the existing aperture width is to be increased, it is a legal requirement that Building Regulation approval is obtained.

The necessity for lintels is dependent on the design of the structure, however even if no lintel is fitted above the existing aperture, the installation company is responsible for assessing if lintels should be installed because of potential movement in the brickwork. If required, a lintel should be installed. The installation company cannot avoid the issue on the grounds that because the original window did not have a lintel, then the replacement does not need one either. The installation company is responsible for advising whether or not lintels are required. A disclaimer issued by the customer is not an acceptable practice.

If a lintel is required, the lintel contract can be separate from the window contract and a separate cost would be involved. The installation company would be within their rights to charge for the lintels and for them to be installed. Retrospective remedial work required due to the lintels not being installed would normally be at the installation company's cost.

Brickwork Removal

Where bricks are to be removed to install products, the method of any cavity closing should be specified. The method of making good should be agreed with customer.

Note: It is advisable to consult Local Authority Building Control to ensure that any local interpretations, for instance with respect to cavity closing or window to French door conversion are taken into account.

Section 2: Surveying

Bow, Oriel and Dormer Windows

If bow, oriel or dormer windows have applied loads, a structural assessment should be carried out by a competent person. Care should be taken to ensure that adequate provision is made to support the weight of the replacement window.

Consideration should also be given to the insulation requirements of any protruding internal element e.g. extended window board.

Bay Windows

Where bay windows are to be replaced, care should be taken to determine the loads present within the existing bay in order that adequate support is provided during the removal.

It is also important to specify the appropriate bay poles according to these loads which will ensure the structure is not compromised.

Further details can be found within this guide under Part A of the Building Regulations

Roof Windows

Health and Safety requirements for working at height must be taken into consideration. Additionally an area of ground/floor directly below the window may need to be cordoned off for safety against materials or tools being dropped from roof level during the time the work is carried out.

The condition of the existing roofing material and roof structure should be assessed along with felting detail around the window frame upstand, insulation within the gap between the window frame and roof structure and vapour barrier. If remedial work or adjustment is required to any of these, - particularly to the roof structure - this should be brought to the attention of the customer. Alterations/adjustments to the roof structure may come under the aspects of the Building Regulations. It is advised that where possible, new felt, insulation and vapour barrier be provided if not already present. A new flashing set compatible with the roofing material will be required.

The type and size code for the roof window can be found either between the two individual panes of glass or on the data plate at the head of the sash depending on the age of the roof window. This should then be compared to the current product offering to determine which product is suitable to replace the existing window. The choice of product should reflect the necessity to comply with the relevant Building Regulations.

Section 2: Surveying

Coupled / Combination frames

Where windows and / or doorsets are to be coupled, the surveyor should determine the method to be used taking into account wind and dead loads, visual appearance and position of the coupling.

Opening type and direction

The surveyor should confirm with the customer whether the window or door is to be inward or outward opening and the handing. On outward opening doors, it is recommended that a restriction device is fitted, e.g. a doorstop, to help avoid damage caused by e.g. sudden wind gusts. The protrusion of outward opening windows or doors into the path of pedestrians should be avoided where possible.

Doorsets

Part M of the Building Regulations does not require the installation of a door with better access than the existing. However, it is good practice to consider the requirements of the occupants and improve access into the dwelling if necessary e.g. by reducing the threshold height.

The size and location of any letter plate should be confirmed with the customer.

Note: Reference may be made to BS EN 13724 which gives guidance on the apertures of private letter boxes and letter plates.

The requirement for additional hardware such as trickle vents, cat flaps, spy holes etc. should be clearly specified.

On doorsets with side panels, it may be necessary to additionally stiffen the mullion to ensure rigidity when the door is closed against it.

Section 2: Surveying

Frame Drainage

Any method of frame drainage should be specified to ensure that drainage water is effectively shed from the window and does not come into contact with parts of the fabric of the building that are not designed for that purpose.

Decorative Glazing

The surveyor should specify or confirm the position, style and orientation of any glass pattern or decoration including leading or Georgian Bar inserts and the need for alignment.

Measurement

Three measurements of width and height should be taken and the squareness of the aperture determined by taking diagonal measurements, see Figure 1. The smallest measurement of width and height is used to determine manufacturing sizes. The need for any sub-sill should be determined. The size of the sub-sill should be such that there is an adequate overhang of at least 25mm from the face of the building. The surveyor should determine how the sub-sill is to be fitted taking into account features such as horns, and how any making good is to be carried out. The difference between internal and external reveal sizes should be determined and checks made to ensure that the operation of any opening light will not be impeded by plaster, render or tiles etc

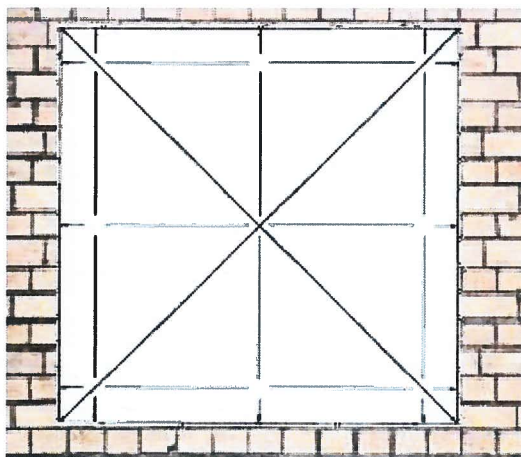

Figure 1 - Squareness measurements

Section 2: Surveying

In-check reveal (reverse brick detail or rebate opening)

These are openings that are constructed so that the outer face dimension is smaller than the internal often found in areas of high exposure to severe weather conditions.

Other examples can be found in properties with box-sash windows where the side boxes are hidden behind the face brickwork.

It is good practice to ensure that windows on a single elevation should ideally have a consistent amount of visible frame at the sides. Similarly windows on a single elevation should ideally have a consistent amount of visible frame at the head.

In the case of Box Sash windows, it is a good idea to remove an internal architrave from the window to see exactly how deep the reverse brick detail really is, and to identify how much of the outer frame can be put behind the face brickwork. A hole should be drilled through the head of the existing box frame to ascertain the maximum height the window can be put behind the brick. This may differ from the allowance on the width.

Manufacturing sizes

With some framing materials, due consideration should be taken when materials that have significant expansion/contraction under temperature fluctuations are to be used. Allowances should also be made with regard to the window or doorset and building aperture tolerances. Table 1 gives the deductions that are recommended for windows and external doorsets. When calculating height deductions, due allowances should be also made for the thickness of any sealant or mortar bed at the sub-sill.

Care should be taken to ensure that the thickness of the internal plaster does not hide or obscure the frame, especially on internally beaded systems. A suitable add-on may therefore be required.

Width or height of Structural opening	Up to 1.5m	From 1.5m to 3.0m	From 3.0m to 4.5m [†]	Over 4.5m [†]
Material				
GRP	5	10	15	15
PVC-White	10	10	15	20
PVC-Non-white	15	15	22	28
Timber	5	5	5	5
Steel	8	10	12	15
Aluminium	10	10	15	20

Table 1 - Frame Clearances

Section 2: Surveying

Asbestos

The GGF produce a code of practice for the safe working with any products containing asbestos. The surveyor should work in accordance with this document.

The assessment process can be found within the following flow chart.

Further reference should be made to the GGF

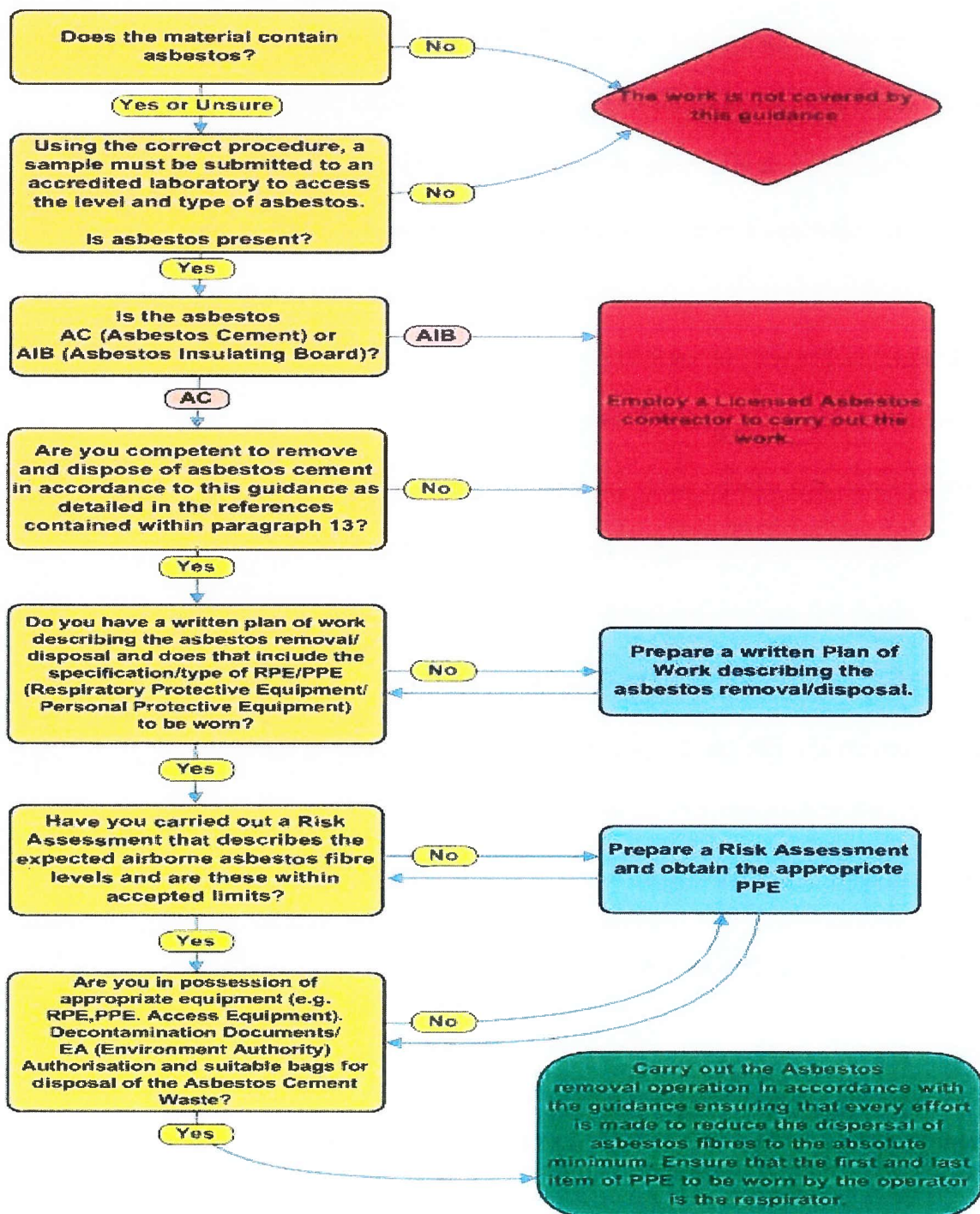

Section 2: Surveying

Surveyor's Check List

	Y/N
Is there any evidence of asbestos that may need to be removed or disturbed?	
Is the condition of the aperture satisfactory and without evidence of damp or cracks?	
Is the aperture square and even to within 5mm height and width and 10mm diagonals?	
Will any loads be carried by the building and not the window or doorset?	
Has the size and method of fixing any sub-sill been determined?	
Will the proposed style function without being fouled by plaster, etc.?	
Will any trickle vents fitted function without being fouled by plaster, etc.?	
Will hinges function without being fouled by plaster, etc.?	
Are curtain tracks and nets clear of proposed design?	
Is the size and configuration within the manufacturer's limits?	
Will the products exposure category be suitable for the location?	
Will the installation comply with Building Regulations?	
Is the method of drainage appropriate for the installation and product	
Has the customer confirmed the position and handling of opening lights?	
Has any addition hardware been specified?	
Is the access for installation safe?	
Has the fixing method been determined?	
Has the extent of making good been agreed with the customer?	

Note: It may be of benefit to make a photographic record of the existing installation in case of dispute, e.g. Building Regulation compliance.

Section 3: Installation

General

Prior to the commencement of work the sizes, type and condition of all windows and doorsets should be checked both against the survey sizes and types and against the actual aperture sizes.

At the request of the installer, prior to the commencement of the work, the customer should be given adequate notice to remove any furniture, fixtures or fittings that may otherwise be damaged during the installation.

The installer is responsible for both internal and external protection of the property during the installation work.

Floor coverings should be protected and care afforded to decorations and furnishings.

Reasonable steps should be taken to minimise any damage to adjacent reveals.

Wherever possible, the installer should install and seal the new windows and doorsets on the same day that the existing windows or doorsets are removed, to maintain security and weather tightness of the building. If this is not possible, an alternative arrangement for security and weather tightness should be agreed in advance between installer and client.

The existing windows and doorsets should be removed with care to avoid unnecessary damage to the building structure and its finishings and without permitting any subsidence of the superstructure during or after the installation procedure.

Any electrical or specialist items, such as television aerials or telephone wires should be re-routed around the frame of the window. Where this is not feasible, then alternatives should be agreed with the customer. The appropriate service provider should be employed where necessary.

Window removal techniques

Before the removal of existing windows and doorsets is started, a risk assessment should be carried out.

Appropriate protective equipment should be worn at all times and any non-essential personnel should be excluded from the immediate area.

Safe removal of putty-glazed fixed lights is imperative. This should preferably be carried out by removing the putty, glazing sprigs, beads or fixing nails and removing the glazing intact. Alternatively, the glass should be carefully broken, so that the fragments are on the outside of the structure.

It is good practice to run a sharp knife between the inside face of the frame and the adjoining plaster, to minimise damage to the plaster when the frame is removed.

Section 3: Installation

Timber framed windows and doors

Opening casements should be removed first, complete with their glass, by levering the screws from the frames, by unscrewing the hinges, or by cutting through the hinges.

After removal of the casements and fixed light glazing, any mullions and transoms should be cut through and removed from the outer frame of the window.

If the frame fixing nails or screws cannot be found and removed, it will be necessary to cut through the outer frame at an angle which will allow it to be carefully levered from the surrounding aperture - in the plane of the window - so as to cause the minimum of damage to the aperture.

There are often problems with windows under the roof eaves. There may be a brick course resting on the existing frame between the top of the frame and the soffit board. This course is often purely decorative - not load-bearing - and should be wedged into position until the frame has been removed. Also the soffit board - plywood, timber or asbestos cement (see page 17) - is frequently nailed to the existing window frame. This joint should be severed by carefully locating and removing or cutting the nails

Box-sash windows

Most box-sash windows pre-date cavity walls, and are built into the internal reveals of solid brickwork. The sashes can be removed fully glazed.

- a. Remove the mitred beading from around the frame.
- b. Carefully cut the sash cords to release and lower the weights.
- c. Remove the bottom sash, take off the parting bead and then take out the top sash.
- d. Cut the outer frame from the aperture, leaving the horns in the structure.
- e. Remove the counterweight from the sash box.
- f. Remove the sub-sill, if this is not part of the outer frame.

Metal framed windows

There are two distinct methods by which metal windows were fixed.

- Screw-fixed through the frame into timber sub-frames or direct. Firstly remove all glazing from fixed lights, and separate and remove all opening lights from the frames. Then locate the screws holding the metal frame in place and remove them. Finally remove any timber sub-frame as described for timber windows.
- Lug-fixed directly into the aperture. Firstly remove any opening lights with an angle grinder or hacksaw. Then cut through any transoms and mullions and remove them. Remove the lug screws from the frame by driving them through the frame using a suitable punch. Finally cut through each side of the frame with an angle grinder and lever away from the wall, taking care not to damage the fabric of the aperture.

Section 3: Installation

PVC-U framed windows and doors

All of the glazing should be removed by removing the glazing beads. A knife may be required to free the glass where glazing tapes have been used.

Opening lights should be separated from the frame and removed.

It is advisable to remove any trim profiles around the windows to allow easier access and to determine the presence of fixing brackets.

- a. Through-frame fixings can usually be unscrewed to allow the frame to be removed from the aperture. Care should be taken to minimise damage to the fabric of the building.
- b. Fixing brackets can be cut with an angle grinder. Alternatively, it might be possible to remove the screws from the fixing brackets but this will inevitably cause more damage to the window or door surround.

Roof windows

Remove sash from frame. Roofing material and flashing are then removed from around the frame to expose the fixing brackets. Remove screws securing the brackets to the roof structure and remove the frame. At this point the internal lining will either be left in place or removed depending on re-installation principle.

Sub-sills

Sometimes sub-sills, heads, window boards, and mullions are 'horned' into the fabric of the aperture. This may conceal DPC's, and lead to difficulties in removal. Great care should be taken when cutting and levering these items to reduce damage to plaster, renders, and brickwork to a minimum. If the DPC is damaged, then it must be repaired or replaced.

Window and door fixing

For correct window and door fixing, each frame member should be fixed to the structure or to an adjacent frame in order to resist all likely imposed loads which could cause the frame to deflect. These loads might be due to:

- Wind loads
- Operating loads
- Weight
- Accidental impact
- Attempted burglary

Fixing methods are affected by

- The presence or absence of a wall cavity
- The nature and condition of any cavity
- The relative position of the frame and cavity
- The position of the plaster line and the need to minimise disturbance and damage to interior decorations

Section 3: Installation

- The design of the reveal
- Any requirements for fire resistance (timber frame)

Fixings

There are two principal methods of fixing available, which may be used separately or in combination. These are through frame fixings and lug fixings. The manufacturer's instructions should always be followed.

If lug fixings are used they should be of a suitable material to resist corrosion and, if used externally, they should be secured to the wall using "one-way" or other suitable security screws.

Screws should be sized to penetrate at least 25mm into timber, or 40mm into plugged holes in brick, block, or masonry, unless equivalent demonstrable provision can be made by other means, for example by complying with an appropriate structural code. Connections to steelwork up to 2mm thick such as folded sheet lintels should be made with appropriate thread cutting screws. Connections to steelwork over 2mm thick should be into pre-tapped holes with machine screws of minimum 5mm diameter or alternatively with power-driven hardened self-drilling screws.

Other proprietary mechanical fixing methods should be assessed for suitability, preferably by obtaining an appropriate third party assessment.

Fixings should be at least as corrosion-resistant as BS EN 1670:1998, Grade 3.

The presence of pre-cast concrete or steel lintels may make it impracticable or pose severe difficulties in achieving the specified fixing distances. In these instances the use of polyurethane foam has proved a useful adjunct to mechanical fixings. However, foam fixings should never be used as the sole method of fixing the entire frame into the reveal.

Section 3: Installation

Fixing distances

PVC-U windows and doors

Where possible, all four sides of the frame should be secured as follows:-

- Corner fixings should be between 150 mm and 250 mm from the external corner.
- No fixings should be less than 150 mm from the centre line of a mullion or transom.
- Intermediate fixings should be at centres no greater than 600mm.
- There should be a minimum of two fixings on each jamb.

If the head is fixed with polyurethane foam, then the fixings at the head may be as follows:

- Frame width up to 1200mm – no fixings
- Frame width 1201mm to 2400mm – one fixing
- Frame width 2401mm to 3600mm – 2 equally spaced fixings.

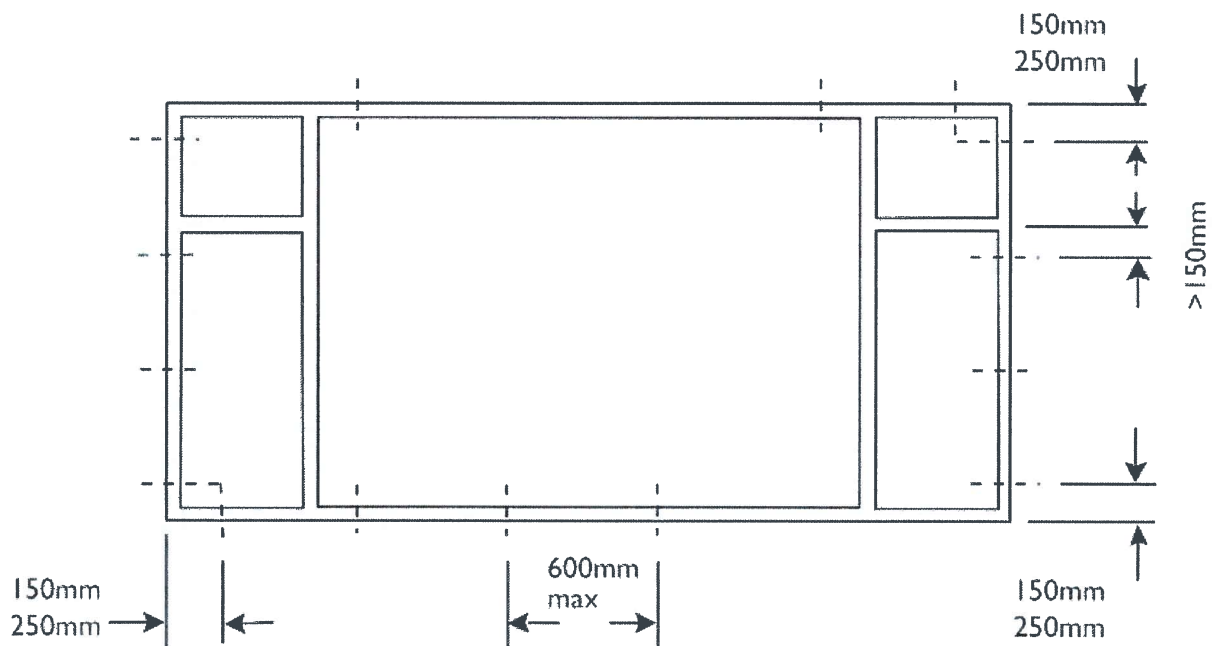

Figure 2 Fixing distances for PVC-U windows

Section 3: Installation

Timber windows and doors

Where possible, the sides of the frame should be secured as follows:-

- Corner jamb fixings should be between 150 mm and 250 mm from the external corner.
- Intermediate fixings should be at centres no greater than 600mm.
- There should be a minimum of two fixings on each jamb.
- On windows over 1800 mm wide, central head and sub-sill fixings should be provided.

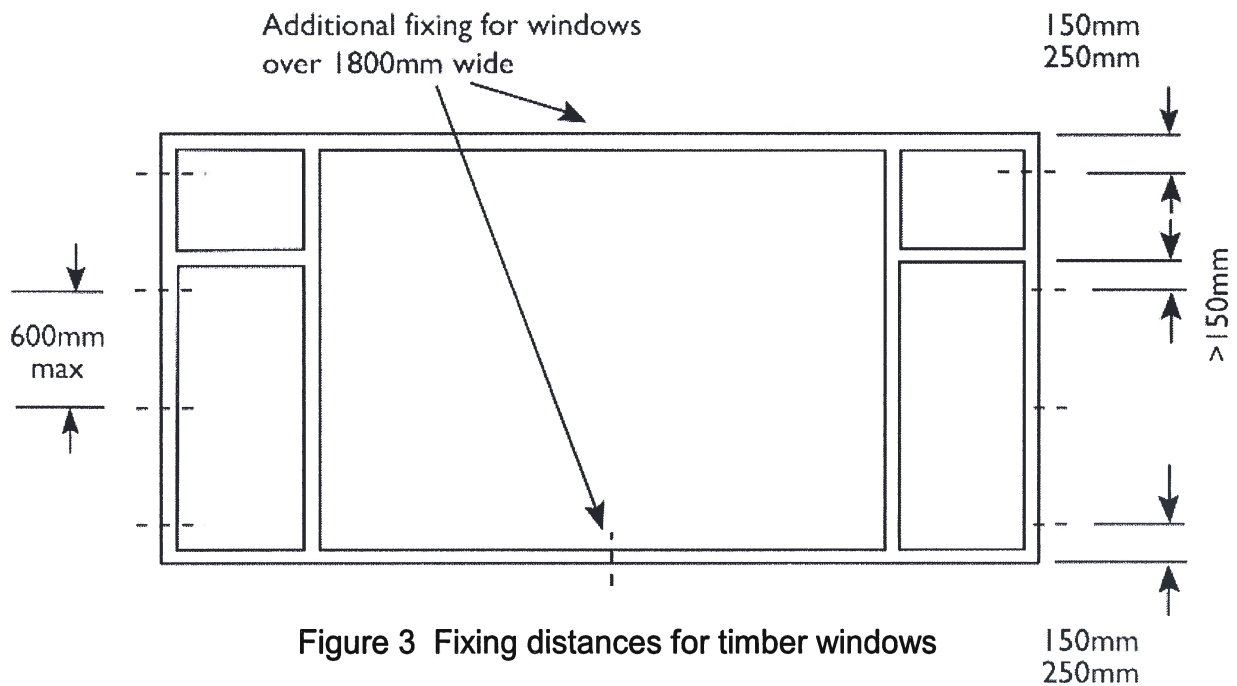

Section 3: Installation

Aluminium windows and doors

Where possible, all four sides of the frame should be secured as follows:-

- Corner jamb fixings should be between 100 mm and 150 mm from the external corner.
- No fixings should be less than 100 mm from the centre line of a mullion or transom
- Intermediate fixings should be at centres no greater than 600mm.
- There should be a minimum of two fixings on each jamb.
- On windows over 1800 mm wide, central head and sub-sill fixings should be provided.

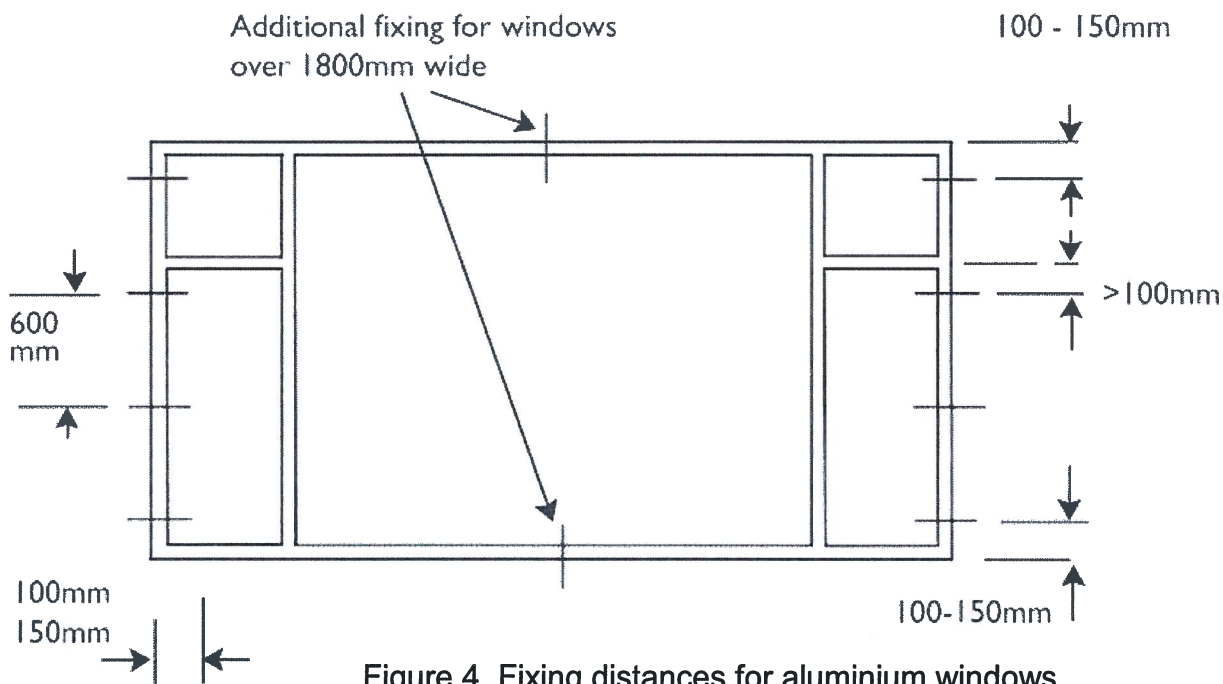

Figure 4 Fixing distances for aluminium windows

Steel windows

The recommended maximum pitch of fixing positions for steel frames of hot rolled solid section is 175mm from corners, and then at 750mm intervals. For steel frames of cold formed hollow section it is 200mm from corners, and then at 900mm intervals. Note that not all holes pierced around the frame perimeter for fabrication and assembly purposes will necessarily require a fixing screw.

Roof windows

Remove sash from frame and install frame into existing aperture using new brackets provided. Provide/renew insulation and felt around frame. Install new flashing and replace roofing material. If internal lining is being replaced provide additional insulation and vapour barrier before fitting new lining.

Section 3: Installation

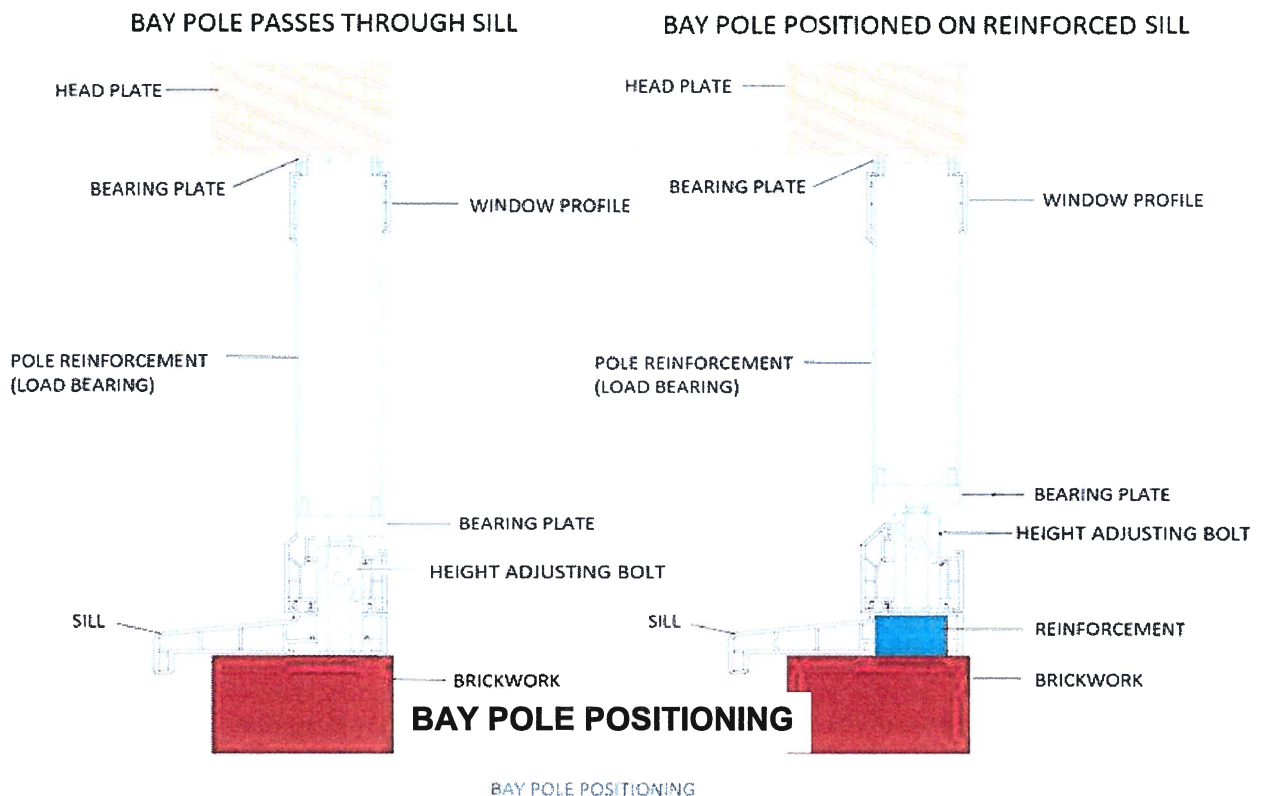

Figure 5

Bay Poles

Where significant loads are being transferred (e.g. several storeys or just a roof) it is recommended that the bay poles are carried through the sill to the bearing plate. If unsure, consult a Structural Engineer

For lesser loads it may be possible to position bay poles directly on to reinforced sills. In this case it is imperative that:

1. the reinforcing system is designed to perform this task, and
2. the system manufacturer's guidelines are followed.

Note: Although Figure 5 shows a Bay Pole jacking system, a load bearing pole using shims is also acceptable.

Section 3: Installation

Installation packers

Installation packers should be used adjacent to fixing positions to prevent outer frame distortion during installation. Installation packers should be resistant to compression, rot and corrosion. They should span the full depth of the outer frame. The fixings should be tightened so that the frame is held securely against the packers. Over-tightening can lead to distortion and should be avoided.

Where enhanced security is required, additional packers might be necessary adjacent to hinge and locking points.

Finishings

Finishings, such as trims, are generally used to neaten the interface between a window and the substrate. They should not be used to provide or enhance the weather tightness of the window or door or the perimeter joints. They should be good exterior quality materials used in accordance with the manufacturer's instructions, and colour matched where specified.

Cellular extruded PVC-UE trims should conform to BS 7619.

Frame position

Replacement windows and doorsets should generally be positioned to minimize the amount of making good, taking into account the following points:-

- a. They should be installed plumb and square within the aperture, without twist, racking or distortion of any member in accordance with the manufacturer's recommended tolerances, to operate correctly after installation and in accordance with the surveyor's instructions.
- b. The new frame should bridge the DPC. Any damaged DPC should be repaired.
- c. The frame should be set as far back in the reveal as is feasible for better weather performance.
- d. The correct movement gap should be provided around the perimeter of the window or door.

Examples of some commonly found reveal details are shown in Annex A

Open cavities

Open cavities discovered between inner and outer skins of brick or blockwork should be closed with an insulating material. Care should be taken to maintain the integrity of the DPC and adequate purchase for fixing screws should be ensured, if necessary with extended fixing lugs.

Section 3: Installation

Box sash windows

When replacing a box sash window into the original check reveal, the window should be fitted from the inside, with the outer frame hidden behind the brickwork.

Packing should be placed at the ends of the sill to transfer the weight of the replacement sash window into the structure without bowing the sill member. A bowed sill will result in the hardware not engaging.

It is essential that the window be fitted level, without twist and with parallel jambs. Jambs bowing outward will make the sash window draughty, and jambs bowing inwards will mean that the sashes will be excessively tight to slide, and will probably not tilt inwards for cleaning (if that option is present).

Expanding foam can be used as an aid to the mechanical fixings, but great care should be taken not to bow the outer frame jambs. If expanding foam is used then packing pieces should be placed between the frame and the sashes, or a brace put across the frame in order to prevent it bowing.

Glazing

All glazing should conform to the recommendations given in the relevant part of BS 6262 and in BS 8000-7. In addition, any glass or insulating glass unit manufacturer's instructions should be followed.

All insulating glass units should be examined for damage prior to installation and defective units should not be used.

Insulating glass units incorporating safety glass should be oriented with the safety glass on the appropriate side.

It is a legal requirement that the marking on the safety glass remains visible after installation.

Insulating glass units with low emissivity coatings should be oriented in accordance with the manufacturer's instructions. Failure to do so can render the coating less effective.

Many windows and doorsets are delivered ready-glazed. Alternatively they can be supplied with glass units and pre-formed glazing gaskets to be applied on site in accordance with the manufacturer's instructions.

Some systems, e.g. steel windows, require butyl-based, polyethylene, PVC or acrylic glazing tapes. When used externally, these glazing tapes should be capped with silicone sealant.

Other systems use non-setting compounds, gun-grade solvent release sealants, one or two part curing sealants or two part rubberizing compounds.

In all cases the manufacturer's instructions should be followed. Insulating glass units should be installed in accordance with BS 8000-7, requiring, where appropriate, the correct use of setting and location blocks, distance pieces, frame to glass and bead to glass gaskets, bead to frame air seals, corner sealing blocks, beads and bead end caps, and bedding and capping sealants.

Section 3: Installation

Scratched glass

The surface of glass can become damaged in a variety of ways.

Scratches, graffiti, pollution and other contaminants are the more common causes which can impair the visual quality of the glazing.

There is a widely held belief that replacement is the only option for damaged glass. This in fact is not always the case.

In common with repairs that are carried out to other building surfaces, on site glass repair by competent GGF members delivers a consistently high quality result that is cost effective, time efficient and sustainable.

The process of repair involves the removal of a minimal amount of the glass surface in order to rectify the defect, without impairing the visual quality.

In some cases the severity of the surface damage may make repair impractical, this would normally be advised during the initial survey. In exceptional circumstances an unacceptable level of distortion may only become evident during or after treatment. In these instances replacement would be advised.

Finishing off and making good

Debris or contaminants should be removed and any drainage paths should be cleared.

Internal reveals should be made good as agreed, ready for the purchaser to redecorate if necessary.

Any materials such as trims or sealant should not be applied on top of loose material.

Protective tapes should be removed as soon as practicable, as ageing of tapes can cause difficulties in removal. Refer to the manufacturer's guidance.

Sand and cement should not be used to fill the gap between the outer frame and the substrate except for backfill for steel windows, usually limited to windows in stone surrounds or interior fair-faced brick and concrete.

Where the replacement product has a smaller front to back dimension than the original, there might be a mastic and/or paint line visible on the substrate which should be removed as much as practicable or covered with a trim.

The method of, and responsibility for, repair to any render should be as agreed with the purchaser.

Sealing

The purpose of perimeter sealants is to repel water and prevent air leakage in the face of differential movement between the aperture and the window. Suitable sealants exhibit and retain flexibility. Sealants should be compatible with the frame, substrate and other materials with which it may come into contact.

The presence of old oil-based mastics and bituminous DPC's can adversely affect the behaviour or appearance of otherwise correctly specified and applied sealants through the migration of hydrocarbons to the surface of the new sealants. Consequent photo-oxidation of the migrant products can affect sealant performance and produce discoloration. This risk should be avoided by removal of unwanted mastic and by keeping sealant away from DPC's.

Section 3: Installation

Perimeter joints should be sealed on both the outside and the inside, with a sealant appropriate to:

- the frame surface
- the substrate material
- joint size and configuration
- anticipated joint movement
- anticipated exposure to weather.

In situations where sealants rely upon atmospheric moisture to initiate curing, deep filling i.e. over 6mm, should be avoided.

The sealant should be applied against a firm backing e.g. foamed PE rod, so that it is forced against the sides of the joint during application. To avoid failure in service, the sealant should not adhere to the backing because this would restrict the lateral movement of the joint. This can be achieved through the use of a closed-cell foam strip such as a polyethylene foam tube.

Wherever practicable, an insulating fill should be inserted or injected around the full perimeter of the frame, between the frame and the structural opening. Any such insulation should be sufficiently flexible that it does not interfere with any expansion and contraction of the frame. Further information can be found within Annex A.

Final Inspection

After installation a final inspection should be carried out, preferably accompanied by the purchaser, to ensure that the installation is fully in accordance with the surveyor's and manufacturer's instructions and that the products operate correctly. An example of a final checklist is given on Page 31.

The purchaser should be made aware of the method of operation, locking and unlocking and fire egress. Written operating and maintenance instructions should be provided.. Ideally, all occupants of a household, other than small children, should carry out the operation of the windows and doorsets, particularly the operation of safety restrictors and their release for egress, in order to identify any difficulties any occupant might have and to agree remedies. Where it is not possible to pass the instructions directly to the occupant, then it is the responsibility of the purchaser to ensure that the instructions are passed on.

Information on the ordering of spare keys should be provided.

In addition, it is good practice to have the purchaser or purchaser's designated representative sign off the installation after the inspection has been passed.

Section 3: Installation

Final Inspection Check List.

		Y/N
Visual appearance	Is the frame installed plumb and square?	
	Is the beading fitted correctly and evenly?	
	Are exposed faces, including beads, free from damage?	
	Is the frame clean with all protective tape removed?	
	Has any damage to aperture been correctly made good?	
	Have all trims been fitted correctly?	
	Has all site debris been removed?	
Glazing	Is all glazing as specified within the contract?	
	Do the sealed units meet current visual quality standards?	
	Are obscure and coated glassed oriented properly?	
	Are sealed unit spacer bars covered by frame and beads?	
	Is the glazing held properly by beads/gaskets, etc.?	
	Is safety glass used where necessary?	
Operation	Do all openers open, close and lock as intended?	
	Are seals on frames without gaps?	
	Are cams free from binding against strikers?	
	Is all operating gear lubricated as necessary?	
	Is all hardware attached with correct numbers of fixings?	
Sight lines	Are all sight lines visually correct?	
	Are adjacent opening lights aligned as appropriate?	
	Are all decorative features, e.g. leading, correctly aligned?	
Sealing	Are all joints smooth and correctly formed?	
	Is the sealant continuous around the frame?	
	Is the frame face free from excess sealant?	
Drainage	Are all drainage channels free from obstruction?	
Miscellaneous	Are all sub-sill end caps fitted if required?	

Section 4: Maintenance

Good quality replacement windows and doors will give many years trouble free service, however a few simple items of regular maintenance will prolong the life of many of the components.

Glass

Cleaning of glass can be carried out using a solution of detergent in warm water. This method is particularly suitable for more heavily soiled surfaces, such as the external face of the glass.

Alternatively, less heavily soiled glass surfaces can be cleaned using a soft cloth and proprietary glass cleaner, in accordance with the manufacturer's instructions.

Laminated, toughened, leaded or low-E glass, and units containing Georgian bars, can all be cleaned in a similar manner.

The glass used in double glazed units can be easily scratched especially by jewellery and metallic scrapers. It is therefore recommended that hand jewellery is removed prior to cleaning and the use of such scrapers be avoided. Care is required when cleaning leaded lights as excessive pressure can dislodge the lead from the glass surface.

Care should be taken not to damage the seals between the frame and the glass.

Note: Externally exposed lead will oxidise - this is a natural phenomenon and does not indicate a fault with the material.

PVC-U Frames

Frames should be washed using a solution of detergent in warm water. This may be conveniently carried out less frequently but at the same time that the glass is cleaned externally. Non-abrasive proprietary cleaners, suitable for PVC-U, can be used in accordance with the manufacturer's instructions.

In the event of unusual or stubborn marks and stains, advice should be sought from the window supplier.

Solvents, thinners, solvent-based cleaners and abrasive cleaners should not be used.

Aluminium Frames

Frames should be washed down with a solution of detergent in warm water at least once a year. In areas where airborne contaminants are more concentrated than usual e.g., near the sea, around swimming pools, in places where industrial air pollution is a known hazard etc - the products will benefit from more regular attention.

Scratches or chips may be touched in by brush using colour matched paint - The manufacturer may be able to supply small bottles of paint to match the stock colours it uses

Section 4: Maintenance

Timber Frames

Advances with painting and coating systems have led to many timber window products not requiring re-coating for many years. Frames should be washed using a solution of detergent in warm water.

Steel Frames

Steel windows, properly maintained can be expected to last the life of the building. Simple measures, such as having the metal frame surfaces washed down at the same time as the glass is cleaned, and undertaking an annual inspection of working parts, gaskets, weatherseals and joint sealants, will do much to ensure their trouble-free performance.

Roof windows

Maintenance should be carried out as recommended by the manufacturer. However timber windows with varnish, lacquer or paint finish should be cleaned as required with ordinary household cleaners.

Periodic maintenance to the surface finish will be required depending on the internal environment and the manufacturer's recommendations for this should be followed.

Timber windows with a polyurethane lacquer finish or UPVC windows should be cleaned periodically with household cleaner.

Fittings should be checked regularly and lubricated if necessary

Externally, the gutters around window should be checked annually to ensure they are free of blockages

Sealants

The sealant between a frame and the building can be cleaned in a similar manner to the frame, taking care not to break the seal to the frame or substrate.

Gaskets & Seals

Gaskets and seals will give many years of performance. However, if they are damaged or reach the end of their useful life, some are designed to be replaceable.

Hardware & Fittings

Oil or light grease should be applied to mechanisms and keeps at least once a year.

A thin film of light oil on friction stays and mechanisms will enhance their corrosion resistance.

Residential door hinges with plastics bushes require no lubrication. The low-friction bushes could be damaged by the application of mineral oil over the long term.

Section 4: Maintenance

Vertical slider spring balances are pre-lubricated and should require no maintenance.

When using spring balances, care must be taken to avoid any lubricant being applied or transferred to the spring balance chambers in the frame. Any such lubricant will impede the effectiveness of the pivot shoe locking system, causing the sash to move around when tilted inwards for cleaning.

Caution is required when using solvent based aerosol lubricants as these may cause damage to the frame material. If in doubt, further advice should be sought from the frame supplier.

Brass metal rapidly tarnishes when exposed to the atmosphere and requires regular polishing. To avoid this, solid brass furniture is usually supplied coated with a protective lacquer to keep it bright. However, if the lacquer becomes scratched or worn away then the underlying brass will naturally tarnish. Advice on removing and re-applying lacquer to brass furniture should be sought from the supplier.

Further advice on the selection, installation and maintenance of hardware is given in GGF Data Sheet 6.7.

Section 4: Maintenance

Annex A - Commonly found reveal details

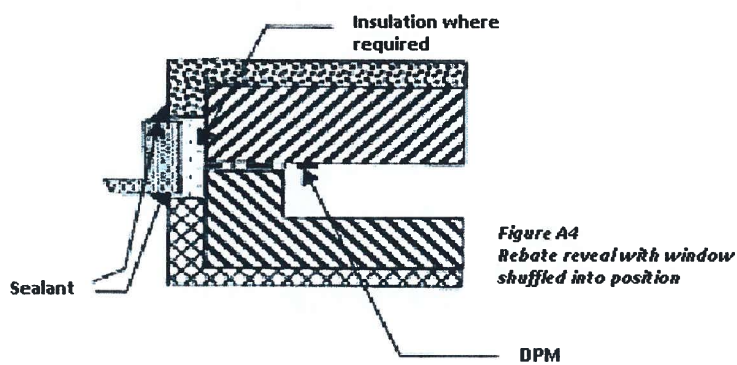
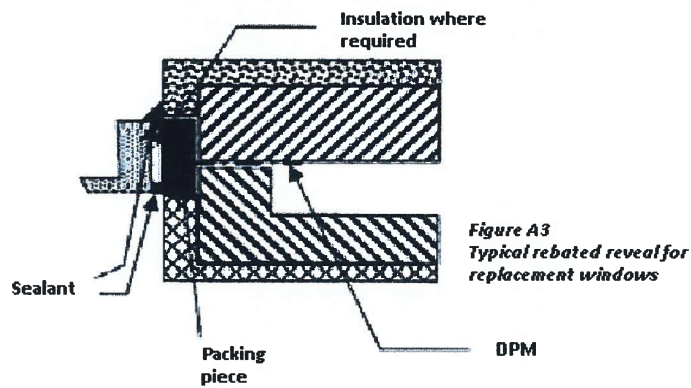
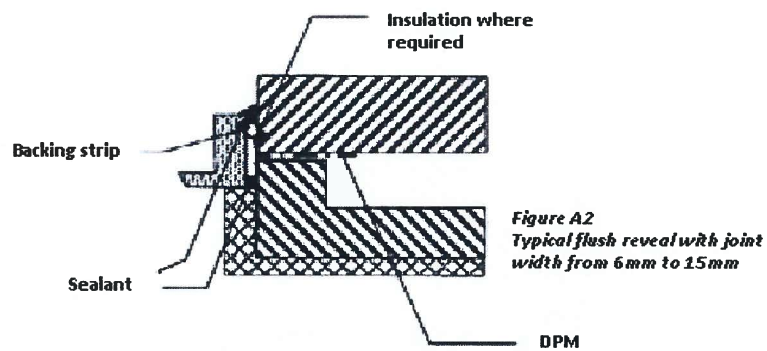
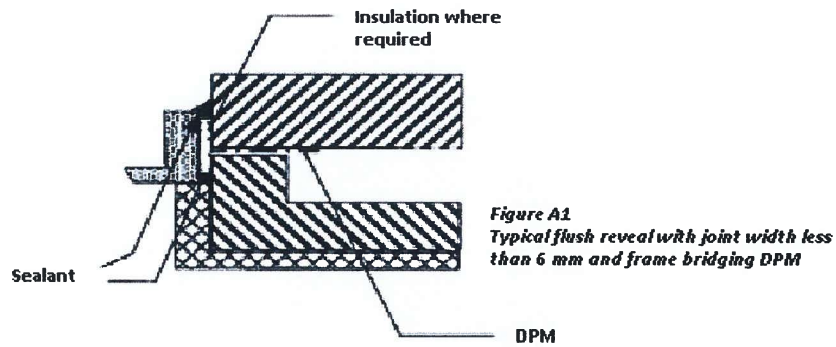

Section 4: Maintenance

Annex A cont.

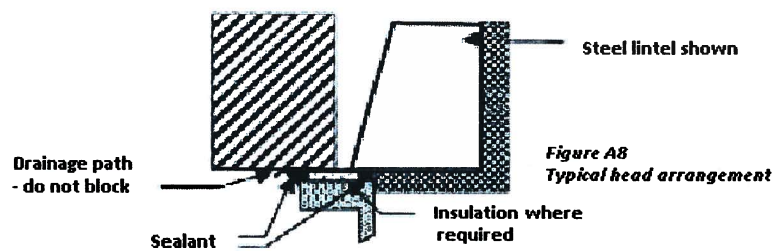
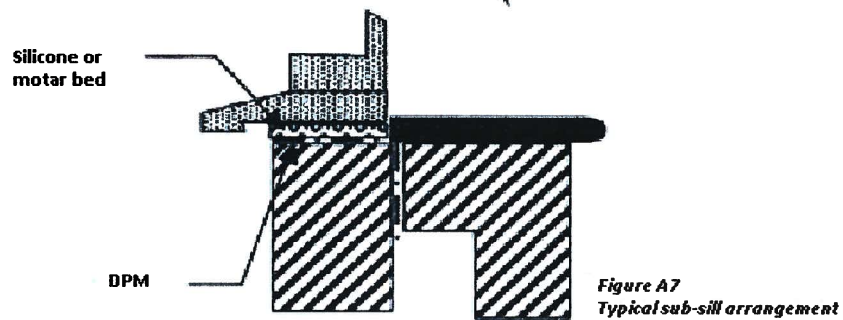
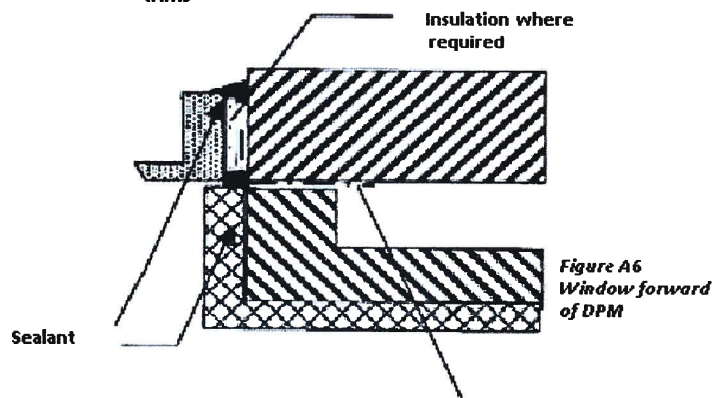
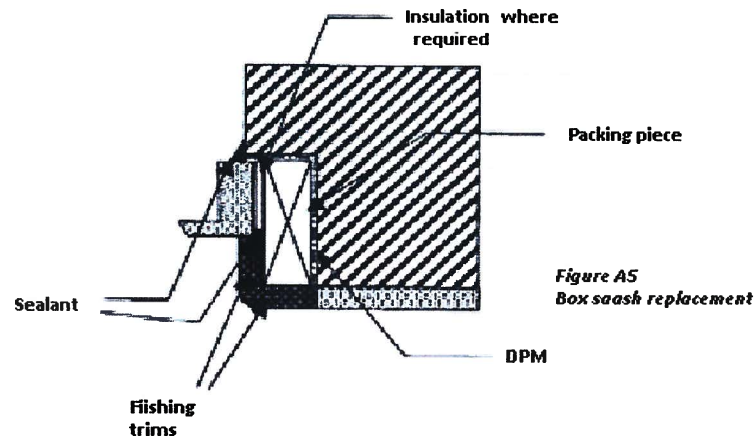

Section 5: Building Regulations

The Building Regulations exist to ensure the health and safety of people in and around all types of buildings. They also provide for energy conservation, access to and use of buildings.

To assist with understanding, CLG (Communities and Local Government), the Government department with responsibility for Building Regulations, in England & Wales, produces an excellent guide written in clear English that will help in understanding why the system works in the way it does.

Hard copies are free from the CLG or it can be downloaded free from their website at:

<http://www.communities.gov.uk/publications/planningandbuilding/buildingregulationsexplanatory>

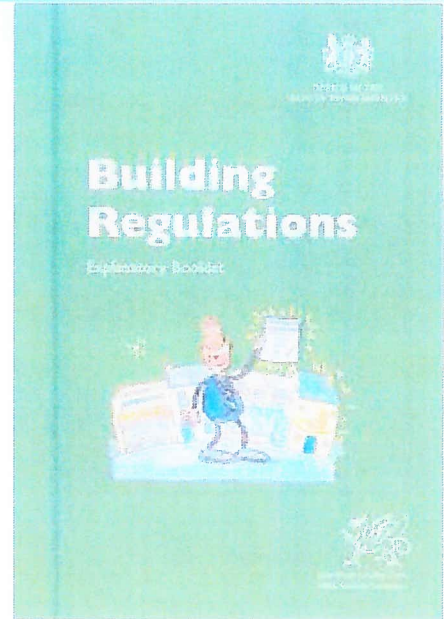

There are many ways in which compliance with the Building Regulations can be achieved. CLG produces a series of guidelines that demonstrate some of the more straightforward ways to achieve compliance with the Regulations. These guidelines are referred to as Approved Documents.

FENSA enables companies that install replacement windows and doors to self certify compliance to the Building Regulations for England and Wales under the Competent Person Scheme.

The Building Regulation Approved Documents

Where windows and doors are to be replaced (but not where they are to be repaired only, as repair work does not fall within the definition of building work) the replacement work should comply with the requirements of Parts L and N of Schedule 1. In addition, after the work has been completed, the building should not have a lesser level of compliance with the other applicable parts of Schedule 1.

Summary: Replacement doors and windows should always comply fully with the requirements of:-

Approved Document L1B – Conservation of fuel and power in existing dwellings

Approved Document N1 – Glazing – Protection against impact

However, for all other applicable parts of the Building Regulations the windows or doors should either comply fully with the requirements of the Approved Documents or, if the item being replaced does not already fully comply, the replacement item should NOT make the non-compliance worse.

Section 5: Building Regulations

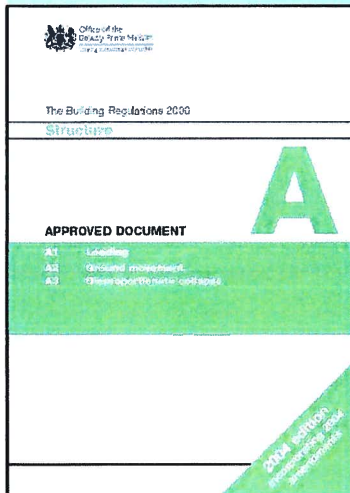

Approved Document A – Structure



Requirement A1

The building shall be constructed so that the combined dead, imposed and wind loads are sustained and transmitted by it to the ground -

- a. Safely; and
- b. Without causing such deflection or deformation of any part of the building, or such movement of the ground, as will impair the stability of any part of another building.

With regard to windows and doors, Approved Document A applies to bay windows and other windows that are load bearing, e.g. where lintels have not been used. When replacing windows and doors it is vital that the integrity of any existing structural support is not compromised.

The supplier of the framing material may be able to offer technical advice.

It is important to note that in situations where uncertainty exists, e.g. when using new materials or construction methods, the services of a structural engineer or other competent person should be employed.

Best Practice Note

Lintels

It is essential to maintain the integrity of the building.

The necessity for lintels is dependent on the design of the structure, however even if no lintel is fitted above the existing aperture, the installation company is responsible for assessing if lintels should be installed because of potential movement in the brickwork. If required, a lintel should be installed. The installation company cannot avoid the issue on the grounds that because the original window did not have a lintel, then the replacement does not need one either. The installation company is responsible for advising whether or not lintels are required. A disclaimer issued by the customer is not an acceptable practice.

Section 5: Building Regulations

If a lintel is required, the lintel contract can be separate from the window contract and a separate cost would be involved. The installation company would be within their rights to charge for the lintels and for them to be installed. Retrospective remedial work required due to the lintels not being installed would normally be at the installation company's cost.



Removal of bay windows

In order to maintain the structural integrity when replacing a bay window, it is essential that temporary supports such as adjustable steel props are used. It is important to ensure that the walls, floors or beams that may be affected by the window replacement are adequately supported prior to removing the windows.

Care should be taken to protect internal ceiling and floor finishes at support bearing points. The sequence of removal of the windows in a two storey bay should ensure that unnecessary damage to the lower bay construction does not occur and structural stability is not impaired. It is important that the structure is always adequately supported.

After supporting the bay structure, the windows should be removed carefully, ensuring that the minimum of damage is caused to reveals, plaster, finishes and trims.

It is recommended that structural mullions are removed one at a time, and that both the temporary supports and the pre-existing structure are closely monitored for any signs of settlement.

Depending upon the design of the structure at the head of the bay window, it may be necessary to leave the head of the frame in position providing that there is no rot present.

If the condition of the aperture or the damp proof membrane (DPM) is not considered to be fit for purpose, or does not correspond with that described by the surveyor, the installer should refer back to the surveyor or the company for agreement to the proposed solution.

Installation of the replacement window assembly should not start until any defects in the structure have been rectified. The assembly of the bay window should follow the product designer's recommendations.

Care should be taken to ensure that no applied loads are carried by the individual segments of the window. Bearing plates should be used on bay poles when loads are transferred from or to masonry or timber.

Where there is no danger of the bay pole damaging the fabric of the building with which it comes into contact, bearing plates are not necessarily required e.g. where the bay pole bears directly onto a steel joist.

Care should be taken to ensure that the loads are transferred correctly from and to the structure of the building and the bay pole assembly. This is achieved either by having the bay pole pass through the sill, or by using a sill which is reinforced strongly enough to transfer the applied loads.

Section 5: Building Regulations

Where significant loads are being transferred (e.g. several storeys or just a roof) it is recommended that the bay poles are carried through the sill to the bearing plate. If unsure, consult a Structural Engineer.



For lesser loads it may be possible to position bay poles directly on to reinforced sills. In this case it is imperative that:

1. the reinforcing system is designed to perform this task, and
2. the system manufacturer's guidelines are followed.

Note 1: If a structural opening is to be made wider, Building Regulation consent is required and should be referred to Local Authority Building Control

Note 2: If the existing structural apertures are found to be unsound prior to the replacement of any windows and/or doors, work should be carried out before hand to ensure the stability of the building.

Section 5: Building Regulations

Approved Document B - Fire Safety

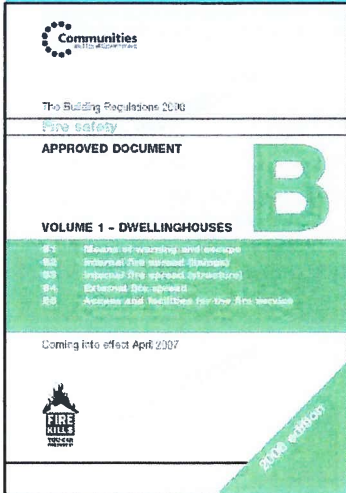

Requirement B1

The building shall be designed and constructed so that there are appropriate provisions for the early warning of fire and appropriate means of escape in case of fire from the building to a place of safety outside the building capable of being safely and effectively used at all material times.

Approved Document B1 states:

Provision for escape from the ground storey

2.3 Except for kitchens all habitable rooms in the ground storey should either:

- a. open directly onto a hall leading to the entrance or other suitable exit; or
- b. be provided with a window (or door) which complies with paragraph 2.8.

Provision for escape from upper floors not more than 4.5 metres above ground level

2.4: Except for kitchens, all habitable rooms in the upper storey(s) of a dwellinghouse served by only one stair should be provided with:

- a. a window (or external door) which complies with paragraph 2.8; or
- b. direct access to a protected stairway

(as described in 2.6 (a) or (b)).

2.6: The dwellinghouse may either have a protected stairway as described in (a) below, or the top floor can be separated and given its own alternative escape route as described in (b).

Section 5: Building Regulations

- a. The upper storeys (those above ground storey) should be served by a protected stairway (protected at all levels) which should either:
 - i. extend to a final exit, see Diagram 2(a); or
 - ii. give access to at least two escape routes at ground level, each delivering to final exits and separated from each other by fire-resisting construction and fire doors, see Diagram 2(b); or
- b. The top storey should be separated from the lower storeys by fire-resisting construction and be provided with an alternative escape route leading to its own final exit.

Emergency egress windows and external doors

2.8 Any window provided for emergency egress purposes and any external door provided for escape should comply with the following conditions.

- a. The window should have an unobstructed openable area that is at least 0.33m² and at least 450mm high and 450mm wide (the route through the window may be at an angle rather than straight through). The bottom of the openable area should be no more than 1100mm above the floor.
- b. the window or door should enable the person escaping to reach a place free from danger from fire. This is a matter for judgement in each case, but, in general, a courtyard or back garden from which there is no exit other than through other buildings would have to be at least as deep as the dwellinghouse is high to be acceptable.

Note 1: Approved Document K Protection from falling, collision and impact specifies a minimum guarding height of 800mm, except in the case of a window in a roof where the bottom of the opening may be 600mm above the floor.

Note 2: Locks (with or without removable keys) and stays may be fitted to egress windows, subject to the stay being fitted with a release catch, which may be child resistant.

Note 3: Windows should be designed such that they will remain in the open position without needing to be held in position by the person during their escape.

Note: Diagrams 2(a) and 2(b) are references to the Approved Document only.

Section 5: Building Regulations

Work on existing houses

2.19 Where windows are to be replaced (but not where they are to be repaired only, as repair work to windows does not fall within the definition of building work) the replacement work should comply with the requirements of Parts L and N of Schedule 1. In addition, the building should not have a lesser level of compliance, after the work has been completed, with other applicable parts of Schedule 1.



For the purposes of Part B1, where a window is located such that, in a new dwellinghouse, an escape window would be necessary and the window is of sufficient size that it could be used for the purposes of escape then:

- a. the replacement window opening should be sized to provide at least the same potential for escape as the window it replaces; or
- b. where the original window is larger than necessary for the purposes of escape, the window opening could be reduced down to the minimum specified in paragraph 2.8.

Summary:

Refer to figure 6 to determine if a fire egress window is required.

A fire escape window is required on the ground floor in any habitable room that does not open onto a hall leading directly to an exit door e.g. an inner room or a final exit door,

A fire escape window is required on upper floors not more than 4.5m above ground level in every habitable room (unless the room has direct access to a “protected stairway”). This is usually the case for the upstairs of a conventional two-storey dwelling.

A habitable room does not include a kitchen or a bathroom.

Upper floors more than 4.5m above ground level should be accessed by a “protected stairway” or an alternative escape route and therefore fire escape windows are not required.

There is no requirement to have more than one escape window in a room.

A fire escape window should have an unobstructed openable area that is at least 0.33m² and at least 450mm high or 450mm wide. If one of the dimensions is at the 450mm minimum then the other dimension will need to be at least 734mm to achieve 0.33m². The route through the window may be at an angle rather than straight through.

The bottom of the openable area should be no more than 1100mm above the floor.

If the outgoing window meets the minimum openable area size of 0.33m² and 450mm dimension, then the replacement should meet these minimum requirements however, if the outgoing openable area exceeds the minimum requirements, there is no obligation for the new window to meet this larger size, as long as it meets the minimum requirement of 0.33m² and 450mm. Similarly, if the openable area complies by being less than 1100mm above floor level then the replacement should also comply by being less than 1100mm, but there is no obligation for it to be any lower than 1100mm above floor level even if the outgoing window is lower.

Section 5: Building Regulations

If the outgoing window does not meet the minimum openable area requirements, then the replacement window does not have to meet them, but the area, minimum dimension and height above floor level should not be made worse than the outgoing window.



Use the graph in Figure 7 as a guide to ensure the correct openable area is achieved.

Sizes that intersect above the blue line will comply.

This graphic shows an example of a compliant opening.

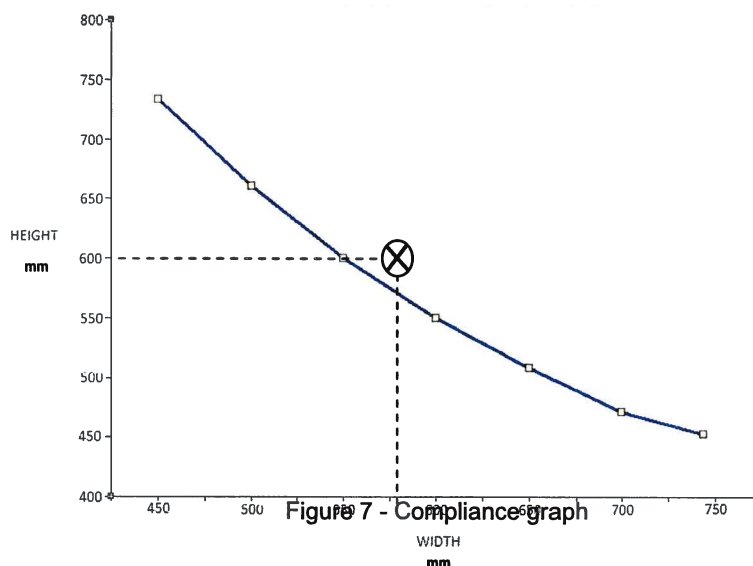

Best Practice Notes

Replacement window hardware

In all windows identified as egress windows, suitable hardware should be installed to maximise the egress opportunity e.g. egress hinges and non key locking handles.

Smoke Detectors

Although it is not the responsibility of the replacement window company, every opportunity should be taken to advise the householder to have adequate working smoke detectors throughout the property to give early warning of fire.

Reducing Compliance

Although it is permissible to reduce compliance to the minimum required by Approved Document B, it is recommended that maximum escape opportunity is retained wherever possible, for example by retaining multiple escape windows in a room, particularly if they are on different elevations.

Non Compliance

If a replacement egress window cannot meet the minimum size requirements as defined within paragraph 2.8 of Approved Document B1 and also the proposed replacement can only provide a smaller egress size than the existing, refer to Local Authority Building Control who may grant dispensation. (this needs to be formally received prior to installation).

Section 5: Building Regulations

Fire Egress Flow Chart FOR GROUND AND UPPER FLOORS NOT MORE THAN 4.5 METRES ABOVE GROUND LEVEL

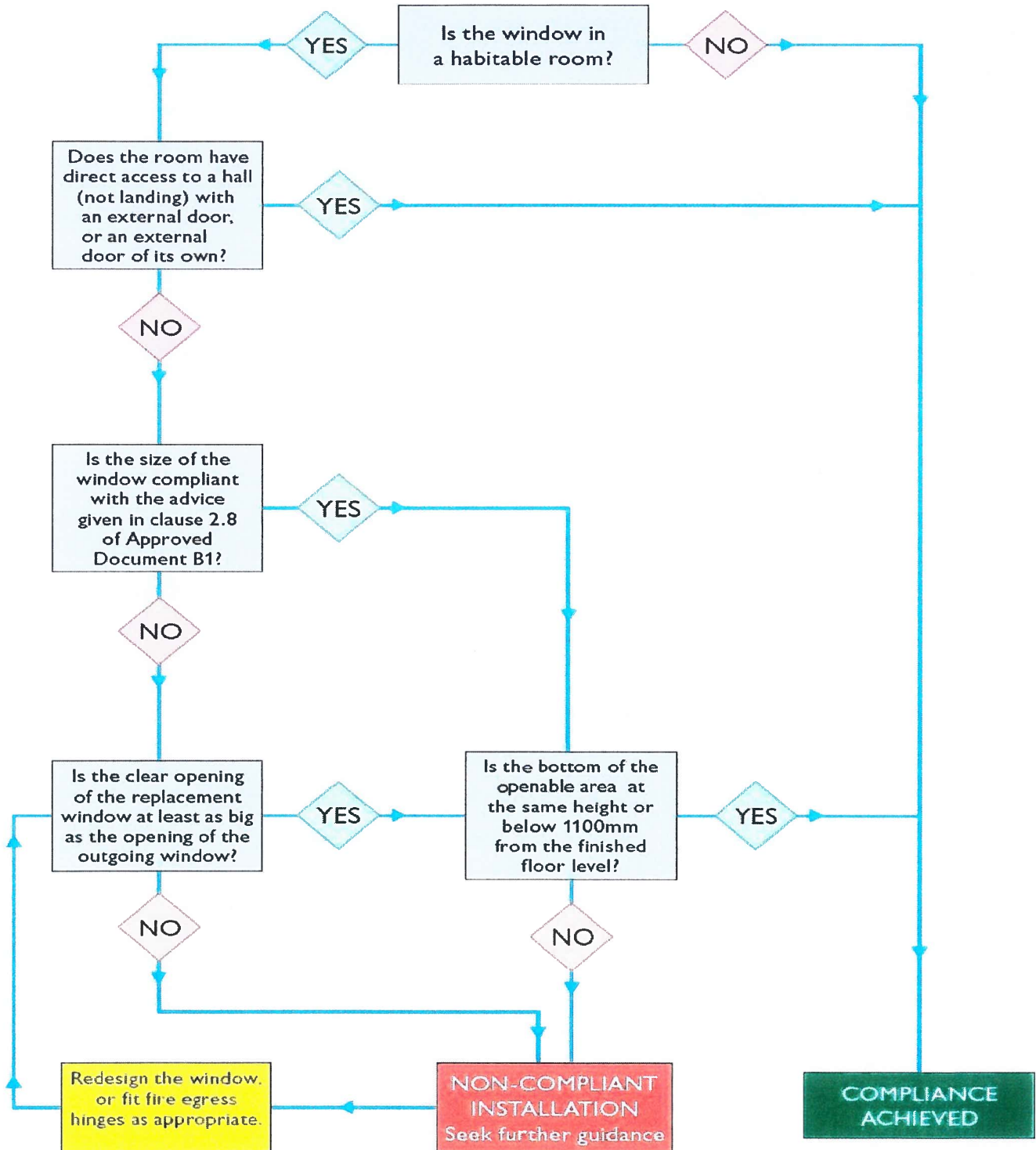
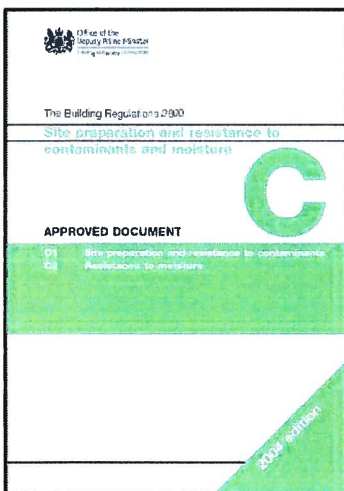
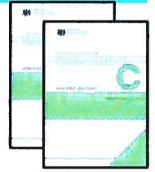

Figure 8

Section 5: Building Regulations



Approved Document C – Site preparation and resistance to contaminants and moisture



Requirement C2

Resistance to moisture

The floors, walls and roofs of the building shall adequately protect the building and people who use the building from harmful effects caused by:

- a. Ground moisture
- b. Precipitation
- c. Interstitial and surface condensation
- d. Spillage of water from or associated with sanitary fittings or fixed appliances

Approved Document C states:

JOINT BETWEEN DOORS AND WINDOWS

5.29 The joint between walls and door and window frames should:

- a. resist the penetration of precipitation to the inside of the building; and
- b. not be damaged by precipitation and not permit precipitation to reach any part of the building which would be damaged by it.

5.30 Damp-proof courses should be provided to direct moisture to the outside:

- a. where downward flow of moisture would be interrupted at an obstruction e.g. at a lintel
- b. where sill elements, including joints, do not form a complete barrier to the transfer of precipitation, e.g. under openings, windows and doors;
- c. where reveals, including joints do not form a complete barrier to the transfer of rain and snow, e.g. at openings, windows and doors.

5.31 In some cases the width of the cavity due to thermal insulation and the 50mm clearance for drainage may be such that the window frame is not wide enough to completely cover the cavity closer. The reveal may need to be lined with plasterboard, dry lining, a support system

Section 5: Building Regulations

or a thermal backing board. Direct plastering of the reveal should only be used with a backing of expanded metal lathe or similar.

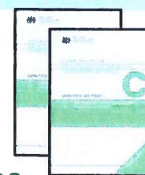

5.32 In areas of the country in driving rain exposure zone 4 checked rebates should be used in all window and door reveals. The frame should be set back behind the outer leaf of masonry, which should overlap it as shown in (Diagram 13). Alternatively an insulated finned cavity closer may be used.

DOOR THRESHOLDS

5.33 Where an accessible threshold is provided to allow unimpeded access, as specified in Part M, Access to and use of buildings, it will meet the requirements if:

- a. the external landing (Diagram 14) is laid to a fall between 1 in 40 and 1 in 60 in a single direction away from the doorway;
- b. the sill leading up to the door threshold has a maximum slope of 15°.

Note: Diagrams 13 and 14 refer to the Approved Document and are not shown in this guide.

Summary:

When existing windows are removed from a cavity wall, the vertical DPC or cavity closer should be inspected to ensure it is complete and un-damaged. Remedial works to ensure compliance should be completed prior to the installation of window.

When existing windows are removed from a cavity wall, the horizontal cavity, DPC or cavity closer at the base of the window should be inspected to ensure moisture will not penetrate from the external skin of the wall to the inner skin of the wall. Remedial works to ensure compliance should be completed prior to the installation of window.

When existing windows are removed from a wall built with a checked rebate, the vertical DPC or cavity closer should be inspected to ensure it is complete and un-damaged. Remedial works to ensure compliance should be completed prior to the installation of window. Windows should be re-fitted with a check rebate to ensure compliance with Approved Document C.

Windows should be installed on a bed of sealant across the sill and beads of sealant applied vertically to the DPC or cavity closer and horizontally across the head of the window to form a seal between the rear of the window and the wall. Either insulation of suitable backing materials such as closed cell foam roll should be used in the gap between the window and wall to ensure the external sealant applied pressure to the frame and wall when applied.

Suitable external sealant should be applied to cover and form a water resistance joint between the frame and wall.

When the existing door is removed, confirm the type of sill detail fitted, this will either be a conventional sill or an accessible threshold sill.

If a conventional sill is fitted, the DPC and vertical DPC should be inspected for damage and if necessary repaired or replaced prior to the installation of the new door. Where a door with

Section 5: Building Regulations

accessible threshold is removed, the original method of installation needs to be determined (e.g. directly onto a concrete sill with a DPC wrapped between the threshold and sill, on a timber sill fitted below finished floor level etc.) and the water tightness of the system confirmed.



If a conventional sill is being installed, the door should be fitted in a similar way as described above for windows.

If an accessible (low) threshold is being installed into an opening that originally had an accessible threshold fitted, the door should be installed in the same manner as the original door was fitted with a DPC between the bottom of the threshold and the stone or timber sill with a sealant between the threshold and DPC.

If an accessible threshold is being installed where a conventional sill was originally fitted, some additional works may be necessary to correct the height of the sill below the door and to ensure surface water is directed away from the door to a suitable drainage channel or run-off.

Details of accessible threshold designs can be obtained from The Stationary Office – Accessible thresholds for new housing or BRE guidance IP17/01.

Doors should be sealed externally as described for windows above but care should be taken to ensure drainage holes in the external face of the threshold are not blocked.

Section 5: Building Regulations

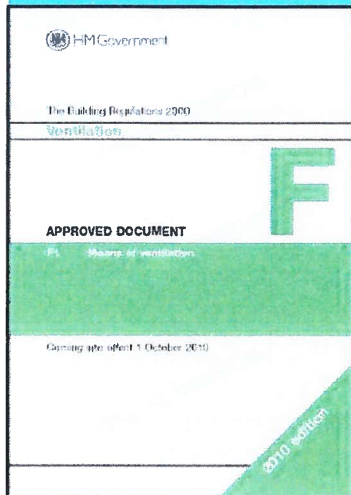

Approved Document F - Ventilation



Requirement F1

There shall be adequate means of ventilation provided for people in the building.

For new dwellings, a target of four air changes per hour is required to ensure suitable ventilation.

The installation of replacement windows should ideally achieve the requirements for new buildings however, if this is not possible the replacement windows should not make the existing capability worse.

There are two different types of ventilation that are required within a building.

1) Purge ventilation

Purge ventilation is required to remove high levels of pollutants and water vapour. It may also improve thermal comfort and reduce overheating during the summer.

Requirements for purge ventilation via windows

For hinged or pivot windows that open 30 degrees or more, or for sliding sash windows, the area of the opening should be at least 1/20th of the floor area of the room.

For a hinged or pivot window that opens less than 30 degrees, the area of the opening should be at least 1/10th of the floor area of the room.

Note 1: For this purpose the opening area of a hinged or pivot window can be taken as the overall width x height of the opening sash.

Note 2: The opening areas for all windows in a room can be added together for the above purpose.

Note 3: It is good practice that any existing high level purge ventilation should be maintained. For example, when replacing a vertical sliding sash window, it is strongly recommended that two opening sashes (vertical slider or two top hung lights) or a tilt turn window are used. If a fixed top light is used, a suitably sized trickle ventilator should be installed.

Section 5: Building Regulations

2) Background ventilation

It is important that the dwelling can constantly breathe - good indoor air quality is important for health and also helps protect the fabric of the building from the harmful effects of condensation and mould etc. Background ventilation helps to achieve this.



Requirements for background ventilation

Where the outgoing window provided background ventilation, the replacement window should also provide background ventilation. It is acceptable for alternative high level ventilation to be provided, e.g. high level air brick. Typically, background ventilation is positioned at least 1.7 metres above finished floor level to avoid discomfort due to draughts.

Where trickle ventilators are used to provide background ventilation then the following performance is required:- habitable rooms 5000 mm² equivalent area. Kitchens, bathrooms and other wet room areas require 2500 mm² equivalent area.

If trickle ventilators are fitted in the window that is being replaced, then a trickle ventilator should be fitted to the new window or an appropriately sized air brick fitted. (Two stage locking handles are not acceptable as an alternative to trickle ventilators.)

If trickle ventilators are not fitted, but two-stage locking handles are fitted in the windows being removed, then either:

- a) trickle vents can be fitted as an alternative, or
- b) two-stage locking handles can be fitted or
- c) appropriate air-bricks can be fitted.

If no ventilation is provided in the windows being removed then a number of options are available to the consumer. Consideration should be given to the fitting of:

- a) trickle vents, or
- b) two-stage locking handles, or
- c) air bricks

The key point is that the building work, once completed, should not have a worse level of compliance than before commencement of the work. Therefore the customer can, in these circumstances, opt not to fit ventilators.

The provision of permanent ventilators for combustion appliances is a mandatory requirement as laid out in Approved Document J. Seek advice from a Gas Safe registered engineer to establish the level of required ventilation. See also Section J within this guidance.

Section 5: Building Regulations



Best Practice Notes

When specifying replacement windows the current level of ventilation in each room should be assessed. If you consider that it is inadequate, advise the customer of the options available. Ensure that whichever method is chosen it meets the necessary level of compliance.

Where the existing purge ventilation area is in excess of the requirements, although it is acceptable to reduce this to the minimum level requirement in the Approved Document, consideration should be given to retaining the existing level.

Section 5: Building Regulations

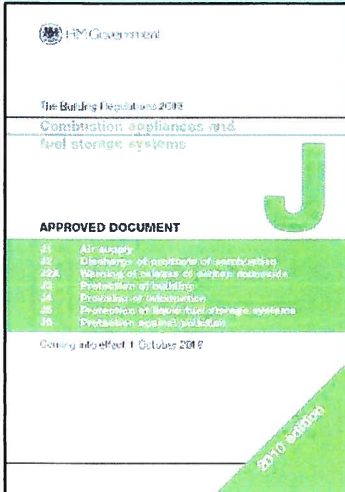

Approved Document J - Combustion appliances and fuel storage systems



Air supply

J1. Combustion appliances shall be so installed that there is an adequate supply of air to them for combustion, to prevent overheating and for the efficient working of any flue.

Discharge of products of combustion

J2. Combustion appliances shall have adequate provision for the discharge of products of combustion to the outside air.

Note: J1 and J2 apply only to fixed combustion appliances (excluding incinerators)

Air supply for combustion appliances

1.2 Combustion appliances require ventilation to supply them with air for combustion. Ventilation is also required to ensure the proper operation of flues or, in the case of flueless appliances, to ensure that the products of combustion are safely dispersed to the outside air. Installation of room-sealed appliances or those with a directly connected ducted external air supply will minimise ventilation energy losses from the room and the risk of cold draughts. In some cases, combustion appliances may also require air for cooling control systems and/or to ensure that casings remain safe to touch (see Diagram 8). General guidance on where it may be necessary to install air vents for these purposes is given below.

1.3 Air vent sizes, which are dependent upon the type of fuel burned, are given in Sections 2, 3 and 4 and are for one combustion appliance only. The air supply provisions will usually need to be increased where a room contains more than one appliance (such as a kitchen containing an open-flued boiler and an open-flued cooker).

Permanently open ventilation of rooms

1.4 A room containing an open-flued appliance may need permanently open air vents. An open-flued appliance should receive a certain amount of air from outside ('combustion air' in Diagram 8) dependent upon its type and rating. Infiltration through the building fabric may be sufficient but for certain appliance ratings and forms of construction, permanent openings are necessary (see Diagram 8).

Section 5: Building Regulations

Approved Document J paragraphs 1.18 and 1.19 make provision for using ventilation which satisfies the requirements for part F and J and states:



1.18 Rooms or spaces intended to contain open-flued combustion appliances may need permanent ventilation to comply with Part J and adjustable ventilation to comply with Part F. Permanently open air vents for combustion appliances can be accepted in place of some or all of the adjustable background ventilation for health, dependent upon opening area and location. However adjustable vents installed to meet the requirements of Part F cannot be used as substitutes for the ventilation openings needed to comply with Part J unless they are fixed permanently open.

Minimum separation distances for terminals in mm

Location		Balanced flue		Open flue		
		Natural draught	Fanned draught	Natural draught	Fanned draught	
A	Below an opening (1)	Appliance rated heat input (net)	Distance in mm	300	(3)	300
		0-7kW	300			
		>7-14kW	600			
		>14-32kW	1500			
		>32kW	2000			
B	Above an opening (1)	0-32kW	300	300	(3)	300
		>32kW	600			
C	Horizontally to an opening (1)	0-7kW	300	300	(3)	300
		>7-14kW	400			
		>14kW	600			

© Crown Copyright

Figure 9

Table extract from Approved document J

1.19. Rooms or spaces intended to contain flueless appliances may need: permanent ventilation and purge ventilation (such as openable windows) to comply with Part J; and adjustable ventilation and rapid ventilation to comply with Part F. Permanent ventilation provisions to comply with Part J may be acceptable in place of adjustable ventilation provisions for Part F subject to the limitations described in Paragraph 1.18. Openable elements installed for the rapid ventilation of rooms and other provisions made for the rapid ventilation of kitchens, in order to comply with Part F, may be acceptable in place of openable elements for the rapid ventilation of rooms or spaces containing flueless appliances.

Limitation on requirements

In accordance with regulation 8 of the Building Regulations, the requirements in Parts A to D, F to K and N and P (except for paragraphs G2, H2 and J6) of Schedule 1 to the Building Regulations do not require anything to be done **except for the purpose of securing reasonable standards of health and safety for persons in or about buildings** (and any others who may be affected by buildings or matters connected with buildings). The replacement window should not make the ventilation requirements any worse for any combustion appliance which is using permanently open vents installed through the window. If a replacement window installer is not sure if a window vent is being used to ventilate a gas appliance, a "Gas Safe" registered gas fitter should be consulted to provide advice.

Section 5: Building Regulations

Particular care should be taken when installing replacement windows in rooms with a gas cooker, provision for a gas cooker or other flueless appliances such as water or space heaters.



In the case of a gas cooker (or provision for a gas cooker), the size of permanently open ventilation is dependant on the volume of the room, if the room is below 5m³ free area of permanent ventilation is 10,000mm², between 5m³ and 10m³, 5,000 mm² (no permanent opening required if the room has a door that opens directly to outside) and over 10 m³, no permanently open vent needed.

Instantaneous water heaters require the same permanently open ventilation but the volume limits are under 10m³, between 10m³ and 20m³ and over 20 m³ respectively.

Space heaters installed in areas not classed as internal space, i.e.. a room which communicates with several other rooms or spaces, e.g. a hallway or landing, requires permanently open ventilation of 10,000 mm² plus 5,500 mm² per kW input (net) in excess of 2.7kW (net).

Space heaters installed in an internal space, e.g. a lounge, requires permanently open ventilation of 10,000 mm² plus 2,750mm² per kW input (net) in excess of 5.4kW (net).

If there is any doubt regarding the amount and provision of permanently open ventilation, the issue should be referred to a "Gas Safe" registered gas fitter to provide advice.

Outlets from flues

3.23 Outlets from flues should be so situated externally as to allow the dispersal of products of combustion and, if a balanced flue, the intake of air.

A way of meeting this requirement would be to locate flue outlets as shown in Diagram 34.

Extract from Approved Document J 'Table to Diagram 34'

Location of outlets from flues serving gas appliances

1. An opening here means an openable element, such as an openable window or a fixed opening such as an air vent. However, the outlet should not be nearer than 150mm (fanned draught) or 300mm (natural draught) to an opening into the building fabric formed for the purpose of accommodating a built-in element, such as a window frame.
2. N/A to this section of the table.
3. Should not be used.

Note: Diagram 34 refers to the Approved Document and is not shown in this guide.

Section 5: Building Regulations

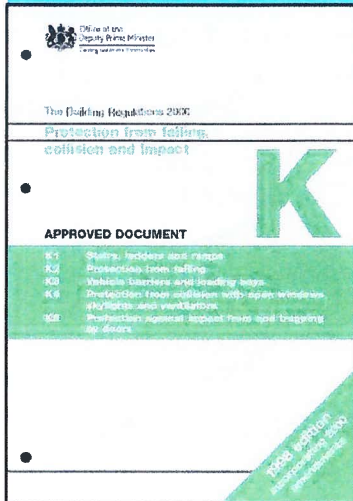

Approved Document K - Protection from falling, collision and impact



Requirement K2. Protection from falling

- a) Any stairs, ramps, floors and balconies and any roof to which people have access, and
- b) any light well, basement area or similar sunken area connected to a building, shall be provided with barriers where it is necessary to protect people in or about the building from falling.

Approved document K2 states:

In the Secretary of State's view the requirements of K2 and K3 will be met if, in order to reduce the risk to the safety of people in and about the buildings:

- a. pedestrian guarding is provided in dwellings which is capable of preventing people being injured by falling from a height of more than 600mm
 - 3.1 **Siting:** Guarding should be provided where it is reasonably necessary for safety to guard the edges of any part of a floor (including the edge below an opening window)
 - 3.2 **Design:** Any wall, parapet, balustrade or similar obstruction may serve as guarding. Guarding should be at least the height shown in Diagram 11 of Approved Document K. Guarding should be capable of resisting at least the horizontal force given in BS EN 1991

For further guidance on design of barriers and infill panels, reference should be made to BS 6180 Code of practice for protective barriers in and around buildings.

The Regulation applies to fixed glazing and opening lights less than 800mm above floor level, where the floor (or stairs or landing) adjacent to a window is more than 600mm above the outside ground level.

It usually means that low-level opening lights should have restricted openers and all low-level glazing should be sufficiently robust to resist likely impact.

Compliance can also be achieved by providing alternative guarding e.g. a guard rail or other fixed barrier, which should cover the zone 800mm above the floor.

For replacement windows and doors the obligation is to make compliance no worse. A replacement window with a qualifying low-level opening light should be fitted with a restrictor if

Section 5: Building Regulations

the outgoing window was fitted with one. If a new qualifying low-level opening light is introduced into a replacement window then this should be restricted.

Any fixed glazing less than 800mm above floor level which acts as a barrier to prevent people falling out should be replaced with glazing which meets the impact resistance requirements of BS 6262-4 taking into account Approved Document K for containment.



Best Practice Note

It is recommended that restrictors are always fitted to opening lights less than 800mm above floor level.

Reference should also be made to Approved Document N Glazing - Safety in relation to impact... for information on safety glazing materials.

Section 5: Building Regulations

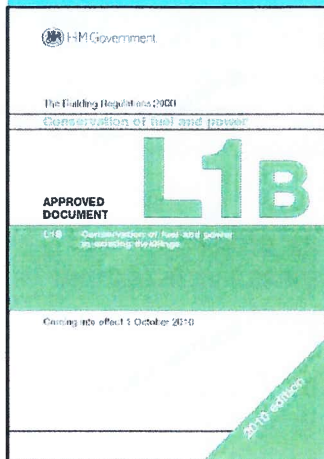

Approved Document L - Conservation of fuel and power



Requirement L1B

- (1) Where a person intends to renovate a thermal element, such work shall be carried out as is necessary to ensure that the whole thermal element complies with the requirements of paragraph L1(a)(i) of schedule 1
- (2) Where a thermal element is replaced, the new thermal element shall comply with the requirements of paragraph L1(a)(i) of schedule 1

Windows

To comply with the 2010 edition of Approved Document L1B, replacement windows should comply with one of the following:

- a) Window Energy Rating minimum (WER) band C
- b) Whole window U -Value maximum $1.6 \text{ (W/m}^2\cdot\text{K)}$
- c) Centre pane U -Value maximum $1.2 \text{ (W/m}^2\cdot\text{K)}$ (For exceptional circumstances only e.g. historic buildings or unique windows).

Doors

All replacement doors should have a U -value not exceeding $1.8 \text{ (W/m}^2\text{K)}$

Table 1 Section 4 Document L1B

Currently for registration of replacement doors through the competent persons scheme, only doors with greater than 50% glazing have to be registered.

British Fenestration Rating Council (BFRC) Window Energy Rating Scheme

The BFRC Window Energy Rating scheme determines the energy rating of a window i.e. demonstrates how energy efficient a particular window is. The scheme takes into account the overall window and not just the insulating glass unit; it measures the window U -value, the solar

Section 5: Building Regulations

gain and the air loss to produce an accurate performance figure which grades the window into one of seven bands A to G. The Window Energy Rating scheme is recognised way of demonstrating compliance similar to that displayed on all new household 'white goods' such as refrigerators, freezers, washing machines, electric ovens etc. that can be found in many retail outlets.



The more efficient the product, the less energy or heat escapes from the property therefore saving the homeowner money and reducing environmental impact. Products that are 'A' rated are the most efficient and those rated 'G' are the least efficient.

Building Regulations ask for a Window Energy Rating Band 'C' or better. This is one of a number of alternative methods to demonstrate compliance.

For additional information on how to gain a BFRC Window Energy Rating, or to see the various options for window installers and fabricators, go to the web site: www.bfrc.org

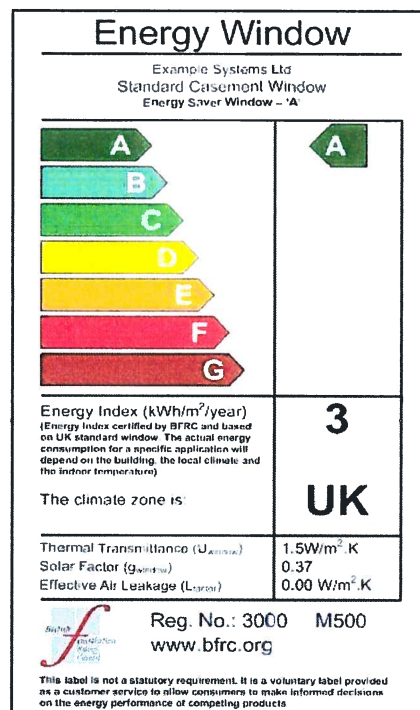

Figure 10 - Energy Saving Label

Best Practice Note:

When replacing windows within a block of flats, consideration should be given to ensure both the Local Authority and the buildings' landlord are informed of your customer's intention. This is particularly important if a design or material change is being proposed.

When replacement combination frames are installed, the glazed area immediately adjacent to the door should be treated as separate windows and registered accordingly. This would include sidelights, top lights and flag windows.

Section 5: Building Regulations

Approved Document M - Access to and use of buildings

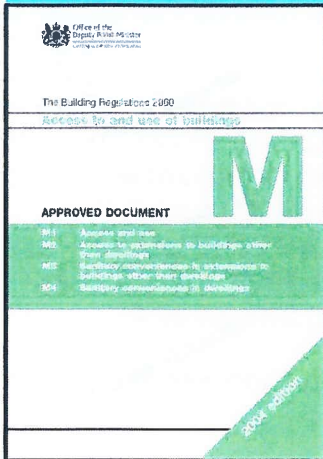

Requirement M1

Reasonable provision shall be made for people to:

- a) Gain access to; and
- b) Use the building and its facilities.

The requirement of Part M is that you should not make the building less accessible than it was before the installation. The height of the sill for a door should not be made worse. In practice there is often a compromise between compliance (not make access worse) and performance (weatherproofing).

When the outgoing door is compliant with new build requirements the replacement shall also be compliant.

Where the door pre-dates the 2004 legal requirements, the installer should make compliance no worse, use best efforts to minimise the hazard and comply with the following:

- a) Protected doorways, and doors in areas of low weather exposure, should be fitted with a threshold sill which gives a height of no greater than 35mm.
- b) Doors in areas of high exposure, and therefore prone to water ingress, should be fitted with a threshold height of no greater than 50mm.
- c) In some situations, due to design considerations, it may not be possible to install a low threshold sill of the requirements as stated above. In these situations, a gap of up to 35 mm measured from the underside of the door leaf to the finished floor level would normally be considered acceptable.
- d) The principal entrance to a dwelling should ideally have a clear opening width of 775mm. When replacing the principal entrance door every practicable effort should be made to retain the maximum width. The clear opening width is taken from the edge of the frame on the latch side to the face of the door leaf when open at 90°.

Section 5: Building Regulations

- e) All door installations should comply with the requirements of Approved Document C in relation to resistance to moisture. If the original principle entrance door was fitted after 2004, it should already be fully compliant with the Building Regulations. If being replaced, only this door needs to meet the requirement specified within Approved Document M. Although other doors replacements within the property should not have a lesser level of compliance, they are not required to meet the requirements of Approved Document M.



Further guidance can be provided by the Stationery Office's publication "Accessible thresholds in new housing: Guidance for house builders and designers".

Best Practice Note

When surveying or specifying a window or door for a dwelling, the surveyor should make note of the person, or persons occupying or using the dwelling. Special consideration should be given to occupants with disabilities. It is not possible to provide a universal solution, so the installation should be suited to the occupants' requirements. These requirements may include low height door thresholds, increased width door sets and suitable positioning and type of door furniture

Section 5: Building Regulations

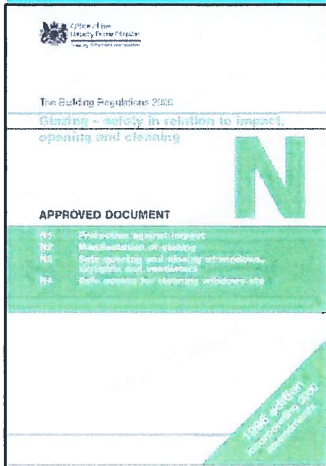

Approved Document N - Glazing - safety in relation to impact, opening and cleaning



Requirement N1.

Glazing, with which people are likely to come into contact whilst moving in or about the building, shall:

- If broken on impact, break in a way which is unlikely to cause injury or
- Resist impact without breaking
- Be shielded or protected from impact.

Safety in use

Where do safety-glazing materials need to be used?

Critical Safety Area Locations

Part of a door, wall or other part of a building likely to be subject to accidental human impact.

Those areas of internal and external walls see Figure 6, that are considered 'critical locations' in terms of safety are:

- Between the finished floor level and 1500mm above that level in doors, and side panels which are within 300mm of either edge of the door.
- Between the finished floor level and 800mm above that level in the case of windows not included in the point above.

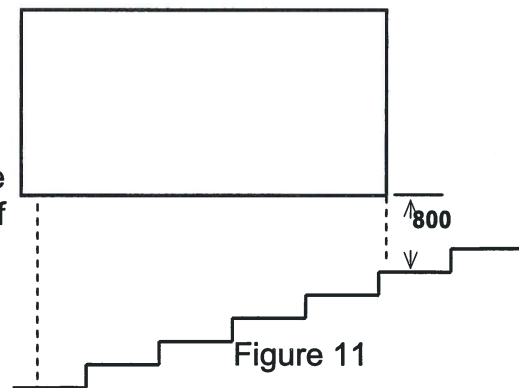

Window on Stairway

Note 1: In bathroom areas where the window is situated adjacent to the bath/shower, the finished floor level is taken from the bottom of the bath or shower cubicle and not the floor level where the bath or shower has been installed.

Section 5: Building Regulations

Note 2: Similarly the drop on stairway is measured from the height of the highest tread within the span of the window. (see Figure 11)

Note 3: Finished floor level would be taken from the top of any floor furnishings that may or may not be in place at the time of the survey. In some cases the ground level outside may vary from inside the property. The smaller of the two dimensions should be used to determine if the window is in a critical location.

It is important to note that any part of a glass area affected should meet the requirements in its entirety and not just in the relevant section.

Note 4: Bay Window seats and other such constructions or permanent fixtures which could be stood upon thereby effectively raising the finished floor level within the vicinity of a window

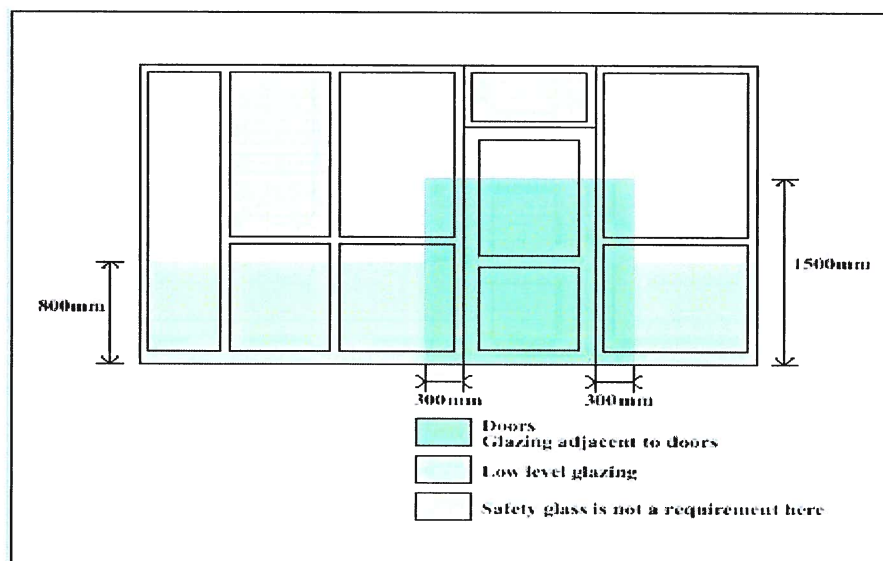

Figure 12

Critical Locations

Shaded areas show critical locations where safety glazing materials should be used.

Exception: Small Panes

Small panes that have a smaller dimension not exceeding 250mm and an area not exceeding 0.5m². Such glass should not be less than 6mm in thickness, except in the case of traditional leaded lights and copper lights, where 4mm can be used.

For further information regarding specifying glazing that will meet impact performance criteria, please refer to BS 6262 - 4 and/or Approved Document N of the Building Regulations.

Best Practice Note

The critical locations set out above for the positioning of safety glazing are minimum requirements. In certain circumstances and in consultation with the customer, it would be advantageous to supply and install safety glazing material in other situations which the surveyor considers hazardous following his risk assessment. Consideration should be given to the type of safety glazing material used. In certain environments the containment of broken safety glass is crucial.

Section 5: Building Regulations

Although not necessarily a permanent fixture, bunk beds positioned under windows could also cause significant risk



Marking of safety glass

Safety glazing definition - according to BS 6262 - 4: 2005, Glazing for Buildings – Part 4: Code of practice for safety related to human impact

Installed safety glass in critical locations should be indelibly and legibly marked in such a position that the whole marking is visible after installation.

The glass should be marked with the following:

- The name and trademark of the manufacturer, merchant or installer;
- The identifier of the product standard that the safety glass conforms to; e.g. BS EN12150, BS EN 14449, etc;
- The classification according to BS EN 12600.

Safety Glass Type	Installed glass – Marking in accordance with	
	BS 6206: 1981	BS 6262 - 4: 2005
Thermally toughened soda lime silicate safety glass	Glass Co. BS 6206 T A	Glass Co. EN 12150 1(C)1, 2 or 3
Laminated safety glass	Glass Co. BS 6206 L B	Glass Co. EN 14449 2 (B)2
Safety wired glass	Glass Co. BS 6206 W C	Glass Co. EN 572-9 3 (B)3

A

Table 2 - Marking of Installed Safety Glass

non-compliance will be recorded during an inspection if the mark is not both completely visible and clearly legible.

Table 2 shows the relationship between safety glazing marking in accordance with Approved Document N and BS6262-4. Polymeric backed safety film can be applied to certain glass types.

Section 5: Building Regulations

The application of the film can provide the glass product with safety characteristics. A European Standard for filmed glass is currently being developed and is expected to be published during the anticipated life of this guide. On publication this Standard should be used. It is recommended that until such time that a European Standard does exist, the word 'Film' should be used in place of the alpha numeric referencing. The products classification to BS EN 12600 shall follow the word 'Film'.



The marking requirements of BS 6262-4 stated that the second and third characters of the classification are not required to be marked on the product. However, the full classification shall be stated within any Construction Products Directive performance declaration.

Note: Approved Document N still refers to BS 6202: 1981. This standard has now been withdrawn. BS 6262-4 2005 should be referenced instead as this is referenced to the European glass product standards.

Best Practice Note

For further information on the use of safety glazing in critical locations, please refer to the GGF publication 'The Right Glazing in the Right Place'

Section 6: Bibliography and Descriptions

BS EN 948: 1999	Hinged or pivoted doors. Determination of the resistance to static torsion
BS EN 1627	Windows, doors, shutters. Burglar resistance. Requirements and classification
BS EN 1628	Windows, doors, shutters. Burglar resistance. Test method for the determination of resistance under static loading
BS EN 1629	Windows, doors, shutters. Burglar resistance. Test method for determination of resistance under dynamic loading
BS EN 1630	Windows, doors, shutters. Burglar resistance. Test method for the determination of resistance to manual burglary attempts
BS EN 1670: 2007	Building hardware. Corrosion resistance. Requirements and test methods
BS EN 1991-1-1	UK National Annex kit Eurocode 1 Actions on structures, General actions. Densities, self weight, imposed loads for buildings.
BS EN ISO 7389: 2003	Building construction -- Jointing products -- Determination of elastic recovery of sealants
BS EN ISO 7390: 2002	Building construction -- Jointing products -- Determination of resistance to flow of sealants
BS EN 12150 -1: 2000	Glass in Building - Thermally toughened soda lime silicate safety glass - Pt 1 Definition and description
BS EN 14351-1 2006	Product standard, performance characteristics - Part 1: windows and external pedestrian doorsets without resistance to fire and smoke leakage characteristics but including fire performance for roof windows.
BS EN 14351-1: 2006	Windows and pedestrian doorsets
BS EN 14449:2005,	Glass in building. Laminated glass and laminated safety glass. Evaluation of conformity/product standard
BS EN 14609:2004,	Windows. Determination of the resistance to static torsion
BS 644: 2009	Timber windows. Factory assembled windows of various types. Specification
BS 6093: 2006	Design of joints and jointing in building construction. Guide
BS 6206: 1981,	Specification for impact performance requirements for flat safety glass and safety plastics for use in buildings
BS 6262 -1: 2005	Glazing for buildings. General methodology for the selection of glazing
BS 6262 - 2: 2005	Glazing for buildings. Code of practice for energy, light and sound

Section 6: Bibliography and Descriptions

BS 6262 - 3: 2005	Glazing for buildings. Code of practice for fire, security and wind loading
BS 6262 - 4: 2005	Glazing for buildings. Code of practice for safety related to human impact
BS 6262 - 6: 2005	Glazing for buildings. Code of practice for special applications
BS 6262 - 7: 2005	Glazing for buildings. Code of practice for provision of information
BS 6375 - 1: 2009	Performance of Windows & Doors. Classification for water tightness and guidance on selection and specification.
BS 6375 - 2: 2009	Performance of windows. Specification for operation and strength characteristics
BS 6375 - 3: 2009	Performance of windows. Specialist Characteristics.
BS 6399 - 2: 1997	Loading for buildings. Code of practice for wind loads
BS 6510: 2005	Steel framed windows and glazed doors.
BS 7412: 2007	Plastic windows made from unplasticized polyvinyl chloride (PVC-U) extruded hollow profiles - Specification.
BS 7950: 1997	Specification for enhanced security performance of casement and tilt and turn windows for domestic applications.
BS 8213 - 1: 2004	Windows doors and rooflights. Design for safety in use and during cleaning of windows, including door-height windows and roof windows. Code of practice
BS 8213 - 4: 2007	Windows, doors and rooflights. Code of practice for the installation of replacement windows and doorsets in dwellings
BS EN ISO 8339: 2005	Building construction -- Sealants - Determination of tensile properties (Extension to break)
BS EN ISO 9046: 2002	Building construction -- Jointing products -- Determination of adhesion/cohesion properties of sealants at constant temperature
BS EN ISO 9047: 2001	Building construction -- Jointing products -- Determination of adhesion/cohesion properties of sealants at variable temperatures
BS EN ISO 10563: 2005	Building construction -- Sealants --- Determination of change in mass and volume
BS EN ISO 10590: 2005	Building construction -- Sealants --- Determination of tensile properties of sealants at maintained extension after immersion in water
PAS 23 -1: 1999	General performance requirements for door assemblies. Single leaf external door assemblies for dwellings.
PAS 24: 2007	Enhanced security performance requirements for door assemblies.

Section 6: Bibliography and Descriptions

Building Regulation Approved Documents:

Approved Document A	Structure (2004 edition)
Approved Document B	Volume 1: Dwellinghouses (2006 Edition)
Approved Document C	Site preparation and resistance to contaminants and moisture
Approved Document E	Resistance to the passage of sound (2003 edition)
Approved Document F	Ventilation (2010 edition)
Approved Document J	Combustion appliances and fuel storage systems
Approved Document K	Protection from falling, collision and impact
Approved Document L1B	Conservation of fuel and power (2010 edition)
Approved document M	Access to and Use of Buildings (2004 edition)
Approved document N	Glazing (1998 edition)

Disclaimer

This Good Practice Guide is produced by the (GGF) and is issued for guidance only. The GGF takes no responsibility for reliance on any advice given, for any omissions from the or for the consequences of users acting in accordance with contents of the guide.

While every attempt is made to present up-to-date information and accurate guidance, any liability on the part of the GGF arising in connection within this guide is expressly disclaimed





Glass and Glazing Federation

54 Ayres Street

London SE1 1EU

Telephone 020 7939 9100

Facsimile 020 7357 7458

www.ggf.org.uk